

Project		Catalog #		Type	
Prepared by		Notes		Date	

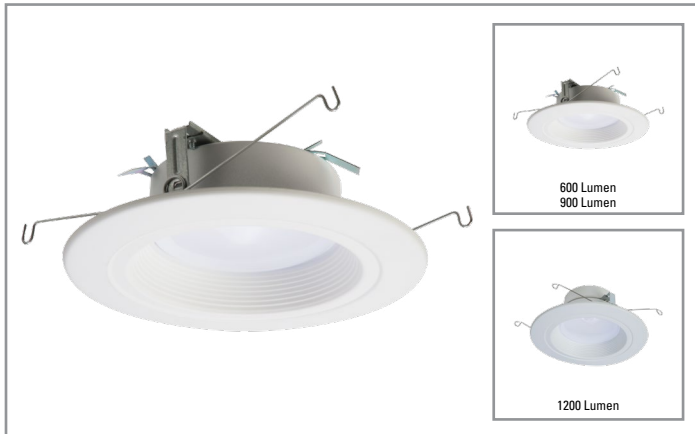

HALO

RL56 | Selectable CCT

5-inch/6-inch All-purpose LED retrofit module with SeleCCTable switch

Typical Applications

Residential

Interactive Menu

- Order Information page 2
- Product Specifications page 3
- Photometric Data page 4
- Energy & Performance Data page 4
- Product Warranty
- Dimming Guide

Product Certification



Refer to ENERGY STAR® Certified Products List.
Can be used to comply with California Title 24 High Efficacy requirements.
Certified to California Appliance Efficiency Database under JAB.

Note: Due to T20 change, as of July 1, 2019 consult factory on correct catalog number and availability for T20 compliant California product.

Product Features



Top Product Features

- Select from 5 CCTs via switch; 2700K, 3000K, 3500K, 4000K, 5000K CCT; 90 CRI
- Lumens: 600, 900, 1200
- Use with 5 or 6" housings with screwbase adapter included
- Dimmable down to 5%
- Dual-mount: Torsion Spring and Push-N-Twist clip models

Dimensional and Mounting Details

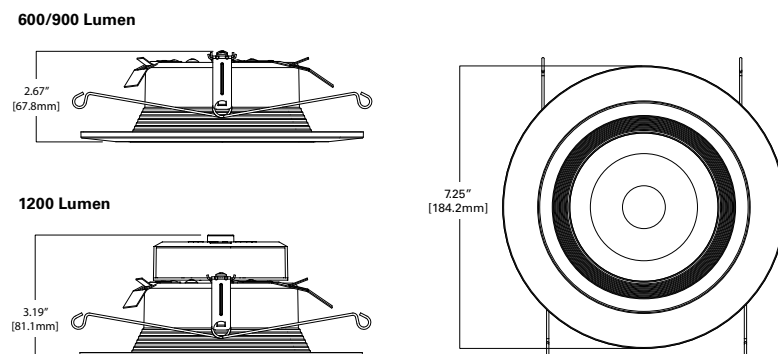

Scale

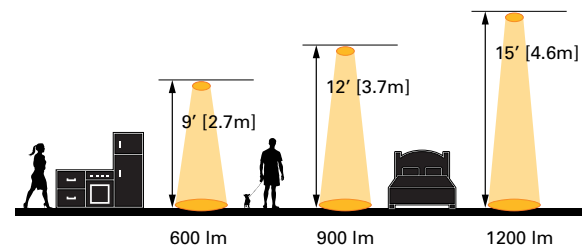

Order Information*

SAMPLE ORDER NUMBER: **RL56069S1EWHR**

Icon Key:  Configurable Product

Models	Lumens	CRI/CCT	Driver	Finish	Packaging	T20 Compliant
RL56 = 5"/6" all- purpose retrofit LED module	06 = 600 lumens (nominal) 09 = 900 lumens (nominal) 12 = 1200 lumens (nominal)	9S = 90 CRI minimum, white tuning, selectable CCT 2700K-5000K	1E = 120V 60Hz leading or trailing edge phase cut 1% dimming	WH = Matte white baffle	R = Recyclable	-CA
Notes	Notes	Notes	Notes	Notes	Notes	Notes

Accessories

Accessories
<p>Designer Trims</p> <p>RL56TRMWHB = 5"/6" White Paintable Trim Ring, Baffle</p> <p>RL56TRMSNB = 5"/6" Satin Nickel Trim Ring, Baffle</p> <p>RL56TRMTBZB = 5"/6" Tuscan Bronze Trim Ring, Baffle</p> <p>RL56TRMWH = 5"/6" White Paintable Trim Ring</p> <p>RL56TRMSN = 5"/6" Satin Nickel Trim Ring</p> <p>RL56TRMTBZ = 5"/6" Tuscan Bronze Trim Ring</p>
Notes

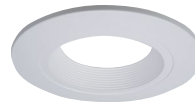

RL56TRMWHB
White (Paintable)

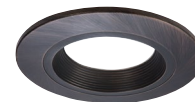

RL56TRMTBZB
Tuscan Bronze

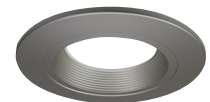

RL56TRMSNB
Satin Nickel



RL56TRMWH
White (Paintable)



RL56TRMTBZ
Tuscan Bronze



RL56TRMSN
Satin Nickel

Housings

Housings	
<p>Halo LED 5-inch</p> <p>H550ICAT = 5" LED, Insulated Ceiling, Air-Tite, New Construction Housing</p> <p>H550RICAT = 5" LED, Insulated Ceiling, Air-Tite, Remodel Housing</p> <p>E550ICAT = 5" LED, Insulated Ceiling, Air-Tite, New Construction Housing</p> <p>E550RICAT = 5" LED, Insulated Ceiling, Air-Tite, Remodel Housing</p> <p>Halo LED 6-inch</p> <p>H750ICAT = 6" LED, Insulated Ceiling, Air-Tite, New Construction Housing</p> <p>H750RICAT = 6" LED, Insulated Ceiling, Air-Tite, Remodel Housing</p> <p>H750T = 6" LED, Non-IC, Air-Tite, New Construction Housing</p> <p>H750TCP = 6" LED, Non-IC, New Construction/Remodel Chicago Plenum Housing</p> <p>H2750ICAT = 6" LED, Shallow, Insulated Ceiling, Air-Tite, New Construction (use with 691X, 694X, 696X trims only)</p> <p>H2750RICAT = 6" LED, Shallow, Insulated Ceiling, Air-Tite, Remodel (use with 691X, 694X, 696X trims only)</p> <p>E750ICAT = 6" LED, Insulated Ceiling, Air-Tite, New Construction Housing</p> <p>E750RICAT = 6" LED, Insulated Ceiling, Air-Tite, Remodel Housing</p> <p>Halo LED retrofit</p> <p>ML7E26RFK = 6" Retrofit Enclosure, Non-IC, E26 Screw base Interface</p> <p>ML7BXFK = 6" Retrofit Enclosure, Non-IC, BX Whip</p> <p>Halo Shallow Housings 5-inch</p> <p>H25ICAT = 5" Shallow, Insulated Ceiling, Air-Tite New Construction</p> <p>H25RICAT = 5" Shallow, Insulated Ceiling, Air-Tite Remodel</p> <p>H25ICATNB = 5" Shallow, Insulated Ceiling, Air-Tite New Construction, No Socket Bracket</p> <p>Halo Shallow Housings 6-inch</p> <p>H27ICAT = 6" Shallow, Insulated Ceiling, Air-Tite New Construction</p> <p>H27RICAT = 6" Shallow, Insulated Ceiling, Air-Tite Remodel Housing</p> <p>H27T = 6" Shallow, Non-IC, New Construction Housing</p> <p>H27RT = 6" Shallow, Non-IC, Remodel Housing</p> <p>E27ICAT = 6" Shallow, Insulated Ceiling, Air-Tite New Construction</p> <p>E27RICAT = 6" Shallow, Insulated Ceiling, Air-Tite Remodel Housing</p> <p>E27TAT = 6" Shallow, Non-IC, New Construction Housing</p> <p>E27RTAT = 6" Shallow, Non-IC, Remodel Housing</p>	<p>Halo Standard Housings 5-inch</p> <p>H5ICAT = 5" Insulated Ceiling, Air-Tite New Construction Housing</p> <p>H5RICAT = 5" Insulated Ceiling, Air-Tite Remodel Housing</p> <p>H5ICATNB = 5" Insulated Ceiling, Air-Tite New Construction Housing, No Socket Bracket</p> <p>H5T = 5" Non-IC, New Construction Housing</p> <p>H5RT = 5" Non-IC, Remodel Housing</p> <p>H5TNB = 5" Non-IC, New Construction Housing, No Socket Bracket</p> <p>E5ICAT = 5" Insulated Ceiling, Air-Tite New Construction Housing</p> <p>E5RICAT = 5" Insulated Ceiling, Air-Tite Remodel Housing</p> <p>E5ICATNB = 5" Insulated Ceiling, Air-Tite New Construction Housing, No Socket Bracket</p> <p>E5TAT = 5" Non-IC, New Construction Housing</p> <p>E5RTAT = 5" Non-IC, Remodel Housing</p> <p>E5TATNB = 5" Non-IC, New Construction Housing, No Socket Bracket</p> <p>Halo Standard Housings 6-inch</p> <p>H7ICAT = 6" Insulated Ceiling, Air-Tite New Construction Housing</p> <p>H7RICAT = 6" Insulated Ceiling, Air-Tite Remodel Housing</p> <p>H7ICT = 6" Insulated Ceiling, New Construction Housing</p> <p>H7RICT = 6" Insulated Ceiling, Remodel Housing</p> <p>H7ICATNB = 6" Insulated Ceiling, Air-Tite New Construction Housing, No Socket Bracket</p> <p>H7ICATNB = 6" Insulated Ceiling, New Construction Housing, No Socket Bracket</p> <p>H7T = 6" Non-IC, New Construction Housing</p> <p>H7RT = 6" Non-IC, Remodel Housing</p> <p>H7TNB = 6" Non-IC, New Construction Housing, No Socket Bracket</p> <p>H7TCP = 6" Non-IC, Chicago Plenum, New Construction/Remodel Housing</p> <p>H7UICAT = 6" Insulated Ceiling, Universal, Air-Tite, New Construction Housing</p> <p>E7ICAT = 6" Insulated Ceiling, Air-Tite New Construction Housing</p> <p>E7RICAT = 6" Insulated Ceiling, Air-Tite Remodel Housing</p> <p>E7ICATNB = 6" Insulated Ceiling, Air-Tite New Construction Housing, No Socket Bracket</p> <p>E7TAT = 6" Non-IC, New Construction Housing</p> <p>E7RTAT = 6" Non-IC, Remodel Housing</p> <p>E7TATNB = 6" Non-IC, New Construction Housing, No Socket Bracket</p>
Notes	

Product Specifications

CCT Select System

- Use the switch to choose between 2700K, 3000K, 3500K, 4000K, and 5000K CCT.

Module - Trim

- Module construction includes LED array, heat sink, reflector, lens, baffle and trim ring.
- Regressed baffle
- Heat sink designed to conduct heat away from the LED array, keeping the junction temperatures below specified maximums, even when installed in insulated ceiling environments.

LED Array

- Mid power LED array provides a uniform source with high efficiency and no pixilation.
- 90 CRI minimum, R9 greater than 50
- Color accuracy at 4 SDCM in between endpoints, provide color accuracy and uniformity.
- Color Temperature (CCT) has a selectable range from 2700K to 5000K (factory default 3000K)

Optical Assembly

- Regressed lens
- Impact-resistant polycarbonate
- Convex form and lamp-like appearance
- Diffuse for even illumination

Driver

- Integral 120V 60 Hz constant current driver provides noise free operation
- Continuous, flicker-free dimming from 100% to 5%.
- Inline electrical quick connect and E26 adapter (provided) provides mains connections
- See Dimming Guide for compatible dimmers

Retention

- Integral torsion springs and Push-N-Twist clips offer two mounting options
- Torsion springs are pre-installed and adjust to fit 5" or 6" compatible housings
- Push-N-Twist universal installation clips are pre-installed and designed to fit 5" or 6" compatible housings

Designer Skins (sold separately)

- RL56 skins are accessory rings that attach to the RL56 for a permanent finish. Refer to the RL56 accessories specification sheet for details.
 - White (Paintable)
 - Satin Nickel
 - Tuscan Bronze

Gaskets

- Closed cell gaskets achieve restrictive airflow requirements without additional caulking

Compliance

- UL Certified
- Wet and Damp location listed.
- Airtight certified per ASTM-E283
- Suitable for use in clothes closets when installed in accordance with the NEC 410.16 spacing requirements
- EMI/RFI emissions per FCC 47CFR Part 15 consumer limits
- Contains no mercury or lead and RoHS compliant
- Photometric testing in accordance with IES LM-79-08
- Lumen maintenance projections in accordance with IES LM-80-08 and TM-21-11
- Can be used for State of California Title 24 high efficacy luminaire compliance. Complies with Title 24 JA8-2016-E.
- Can be used International Energy Conservation Code (IECC) high efficiency luminaire compliance.
- ENERGY STAR® listed, reference database for current listings

Warranty

- Five year limited warranty, consult website for details. www.eaton.com/lighting/legal

Photometric Data

 View IES files

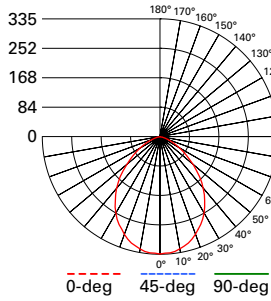

RL56069S1EWHR-3000K

Spacing criterion: (0-180) 1.14
(90-270) 1.14
(Diagonal) 1.22
Beam Angle: 87.8°
Field Angle: 139°
Lumens: 665
Input Watts: 7.6 W
Efficacy: 87.5 LPW
Test Report:
RL56069S1EWHR-3000K.ies

Zonal Lumen	Lumens	% Lumens
0-30	247	37.2
0-40	387	58.2
0-60	595	89.4
0-90	665	100

TM-30-15	Rf = 89.8
	Rg = 98
CRI/CIE	Ra = 93.7
	R9 = 69.1

CCT - Range of 2700K- 5000K



93°

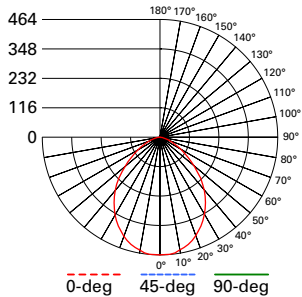

RL56099S1EWHR-3000K

Spacing criterion: (0-180) 1.16
(90-270) 1.16
(Diagonal) 1.22
Beam Angle: 88.9°
Field Angle: 140°
Lumens: 940
Input Watts: 12.1 W
Efficacy: 77.7 LPW
Test Report:
RL56099S1EWHR-3000K.ies

Zonal Lumen	Lumens	% Lumens
0-30	345	36.7
0-40	541	57.5
0-60	838	89.1
0-90	940	100

TM-30-15	Rf = 89.8
	Rg = 97.7
CRI/CIE	Ra = 93.1
	R9 = 64.6

CCT - Range of 2700K- 5000K



93°

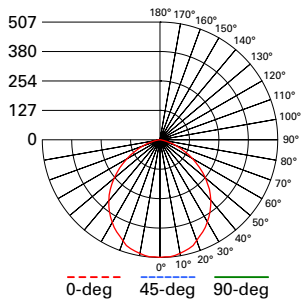

RL56129S1EWHR-3000K

Spacing criterion: (0-180) 1.21
(90-270) 1.21
(Diagonal) 1.31
Beam Angle: 93°
Field Angle: 140°
Lumens: 1221
Input Watts: 14 W
Efficacy: 87.2 LPW
Test Report:
RL56129S1EWHR-3000K.ies

Zonal Lumen	Lumens	% Lumens
0-30	345	31.7
0-40	541	51.5
0-60	838	85.5
0-90	940	100

TM-30-15	Rf = 89.8
	Rg = 97.7
CRI/CIE	Ra = 93.1
	R9 = 64.6

CCT - Range of 2700K- 5000K



93°

Energy and Performance Data

RL56069S1EWHR	
Max. Lumens	712 @ 4000K
Input Voltage	120V
Input Frequency	50/60 Hz
Input Power	7.6W
Input Current	0.15 A
Power Factor	>0.90
THD	<20%
EMI/RFI	FCC Title 47 CFR, Part 15, Class B (Consumer)
Sound Rating	Class A
Minimum Starting Temp	-30°C (-22°F)

RL56099S1EWHR	
Max. Lumens	1006 @ 4000K
Input Voltage	120V
Input Frequency	50/60 Hz
Input Power	12.1W
Input Current	0.15 A
Power Factor	>0.90
THD	<20%
EMI/RFI	FCC Title 47 CFR, Part 15, Class B (Consumer)
Sound Rating	Class A
Minimum Starting Temp	-30°C (-22°F)

RL56129S1EWHR	
Max. Lumens	1272 @ 5000K
Input Voltage	120V
Input Frequency	50/60 Hz
Input Power	14W
Input Current	0.15 A
Power Factor	>0.90
THD	<20%
EMI/RFI	FCC Title 47 CFR, Part 15, Class B (Consumer)
Sound Rating	Class A
Minimum Starting Temp	-30°C (-22°F)

Tested in accordance with IES LM63. Field results may vary.

Note: Refer to IES files for more product data.

Photometric Data

View IES files

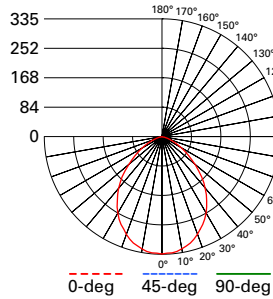

RL56069S1EWHR-CA-3000K
 Spacing criterion: (0-180) 1.14
 (90-270) 1.14
 (Diagonal) 1.22
 Beam Angle: 87.8°
 Field Angle: 139°
 Lumens: 665
 Input Watts: 7.6 W
 Efficacy: 87.5 LPW
 Test Report:
 RL56069S1EWHR-CA-3000K.ies

Zonal Lumen	Lumens	% Lumens
0-30	247	37.2
0-40	387	58.2
0-60	595	89.4
0-90	665	100

TM-30-15	Rf = 89.8
	Rg = 98
CRI/CIE	Ra = 93.7
	R9 = 69.1

CCT - Range of 2700K- 5000K



93°

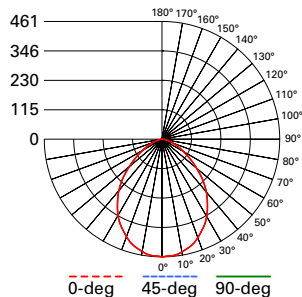

RL56099S1EWHR-CA-3000K
 Spacing criterion: (0-180) 1.13
 (90-270) 1.13
 (Diagonal) 1.21
 Beam Angle: 88.9°
 Field Angle: 140°
 Lumens: 923
 Input Watts: 9.9 W
 Efficacy: 93.1 LPW
 Test Report:
 RL56099S1EWHR-CA-3000K.ies

Zonal Lumen	Lumens	% Lumens
0-30	343	37.2
0-40	536	58.1
0-60	824	89.4
0-90	922	100

TM-30-15	Rf = 89.8
	Rg = 97.7
CRI/CIE	Ra = 93.1
	R9 = 64.6

CCT - Range of 2700K- 5000K

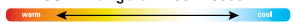

93°

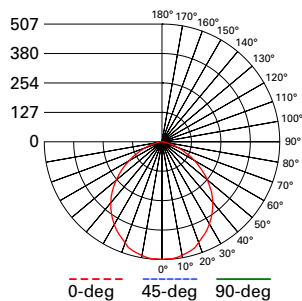

RL56129S1EWHR-CA-3000K
 Spacing criterion: (0-180) 1.21
 (90-270) 1.21
 (Diagonal) 1.31
 Beam Angle: 93°
 Field Angle: 140°
 Lumens: 1221
 Input Watts: 14 W
 Efficacy: 87.2 LPW
 Test Report:
 RL56129S1EWHR-CA-3000K.ies

Zonal Lumen	Lumens	% Lumens
0-30	345	31.7
0-40	541	51.5
0-60	838	85.5
0-90	940	100

TM-30-15	Rf = 89.8
	Rg = 97.7
CRI/CIE	Ra = 93.1
	R9 = 64.6

CCT - Range of 2700K- 5000K



93°

Energy and Performance Data

RL56069S1EWHR-CA	
Max. Lumens	712 @ 4000K
Input Voltage	120V
Input Frequency	50/60 Hz
Input Power	7.6W
Input Current	0.15 A
Power Factor	>0.90
THD	<20%
EMI/RFI	FCC Title 47 CFR, Part 15, Class B (Consumer)
Sound Rating	Class A
Minimum Starting Temp	-30°C (-22°F)

RL56099S1EWHR-CA	
Max. Lumens	946 @ 4000K
Input Voltage	120V
Input Frequency	50/60 Hz
Input Power	9.9W
Input Current	0.15 A
Power Factor	>0.90
THD	<20%
EMI/RFI	FCC Title 47 CFR, Part 15, Class B (Consumer)
Sound Rating	Class A
Minimum Starting Temp	-30°C (-22°F)

RL56129S1EWHR-CA	
Max. Lumens	1272 @ 5000K
Input Voltage	120V
Input Frequency	50/60 Hz
Input Power	14W
Input Current	0.15 A
Power Factor	>0.90
THD	<20%
EMI/RFI	FCC Title 47 CFR, Part 15, Class B (Consumer)
Sound Rating	Class A
Minimum Starting Temp	-30°C (-22°F)