

Project		Catalog #		Type	
Prepared by		Notes		Date	



HALO

RL4 | Selectable CCT

4-inch All-purpose LED retrofit module with SeleCCTable switch

Typical Applications

Residential

Interactive Menu

- Order Information page 2
- Product Specifications page 3
- Photometric Data page 4
- Energy & Performance Data page 4
- Product Warranty
- Dimming Guide

Product Certification



Refer to ENERGY STAR® Certified Products List.
Can be used to comply with California Title 24 High Efficacy requirements.
Certified to California Appliance Efficiency Database under JAG.

Product Features



Top Product Features

- Select from 5 CCTs via switch; 2700K, 3000K, 3500K, 4000K, 5000K CCT; 90 CRI
- Lumens: 600, 900
- Use with 4" housings with screwbase adapter included
- Dimmable down to 5%
- Friction blade mounting

Dimensional and Mounting Details

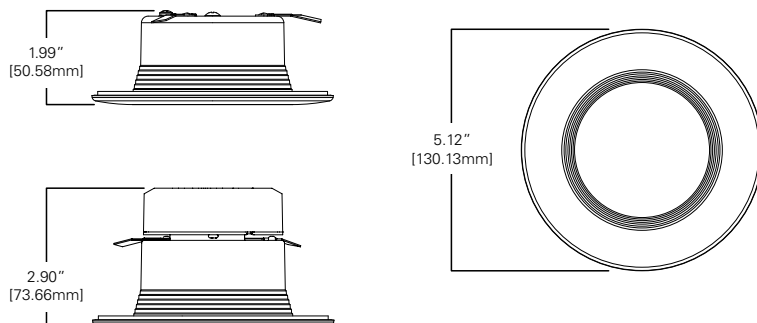

Scale

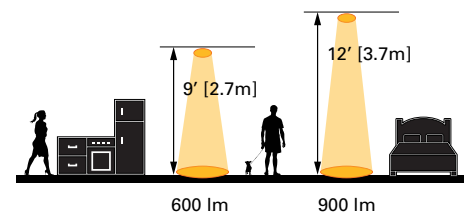

Order Information*

SAMPLE ORDER NUMBER: **RL4069S1EWHR**

Icon Key:  Configurable Product

Models	Lumens	CRI/CCT	Driver	Finish	Packaging
RL4 = 4" all-purpose retrofit LED module	06 = 600 lumens (nominal) 09 = 900 lumens (nominal)	9S = 90 CRI minimum, white tuning, selectable CCT 2700K-5000K	1E = 120V 60Hz leading or trailing edge phase cut 1% dimming	WH = Matte white baffle	R = Recyclable
Notes	Notes	Notes	Notes	Notes	Notes

* For T20 California product, apply "-CA" to the catalog number (ie. RL4069S1EWHR-CA)

Accessories

Accessories
Designer Trims RL4TRMWHB = 4" White Paintable Trim Ring, Baffle RL4TRMSNB = 4" Satin Nickel Trim Ring, Baffle RL4TRMTBZB = 4" Tuscan Bronze Trim Ring, Baffle RL4TRMWH = 4" White Paintable Trim Ring RL4TRMSN = 4" Satin Nickel Trim Ring RL4TRMTBZ = 4" Tuscan Bronze Trim Ring
Notes



RL4TRMWHB
White (Paintable)

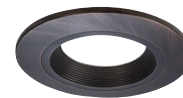

RL4TRMTBZB
Tuscan Bronze

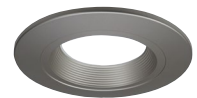

RL4TRMSNB
Satin Nickel



RL4TRMWH
White (Paintable)

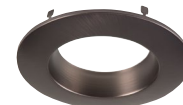

RL4TRMTBZ
Tuscan Bronze



RL4TRMSN
Satin Nickel

Housings

Housings
Halo Ultra-shallow LED Housings H245ICAT = 4" IC, airtight ultra-shallow new construction housing, LED, 120 - 277V H245RICAT = 4" IC, airtight ultra-shallow remodeler housing, LED, 120 - 277V Halo LED Housings H995ICAT = 4" IC, airtight shallow new construction housing, LED, 120 - 277V H995RICAT = 4" IC, airtight shallow remodeler housing, LED, 120 - 277V Halo Housings H99TAT = 4" non-IC, airtight shallow new construction housing, E26, 120V H99RTAT = 4" non-IC, airtight shallow remodeler housing, E26, 120V H99ICAT = 4" IC, airtight shallow new construction housing, E26, 120V E4TATSB = 4" non-IC, airtight shallow new construction housing, adjustable socket bracket, E26, 120V E4RTATSB = 4" non-IC, airtight shallow remodeler housing, adjustable socket bracket, E26, 120V E4ICATSB = 4" non-IC, airtight shallow new construction housing, adjustable socket bracket, E26, 120V
Notes

Product Specifications

CCT Select System

- Use the switch to choose between 2700K, 3000K, 3500K, 4000K, and 5000K CCT.

Module - Trim

- Module construction includes LED array, heat sink, reflector, lens, baffle and trim ring.
- Regressed baffle
- Heat sink designed to conduct heat away from the LED array, keeping the junction temperatures below specified maximums, even when installed in insulated ceiling environments.

LED Array

- Mid power LED array provides a uniform source with high efficiency and no pixilation.
- 90 CRI minimum, R9 greater than 50
- Color accuracy at 4 SDCM in between endpoints, provide color accuracy and uniformity.
- Color Temperature (CCT) has a selectable range from 2700K to 5000K (factory default 3000K)

Optical Assembly

- Regressed lens
- Impact-resistant polycarbonate
- Convex form and lamp-like appearance
- Diffuse for even illumination

Driver

- Integral 120V 60 Hz constant current driver provides noise free operation
- Continuous, flicker-free dimming from 100% to 5%.
- Inline electrical quick connect and E26 adapter (provided) provides mains connections
- See Dimming Guide for compatible dimmers

Retention

- Push-N-Twist universal installation clips
- Clips are pre-installed and designed to fit 4" compatible recessed housings

Designer Skins (sold separately)

- RL4 skins are accessory rings that attach to the RL4 for a permanent finish. Refer to the RL4 accessories specification sheet for details.
 - White (Paintable)
 - Satin Nickel
 - Tuscan Bronze

Gaskets

- Closed cell gaskets achieve restrictive airflow requirements without additional caulking

Compliance

- UL Certified
- Wet and Damp location listed
- Airtight certified per ASTM-E283
- Suitable for use in clothes closets when installed in accordance with the NEC 410.16 spacing requirements
- EMI/RFI emissions per FCC 47CFR Part 15 consumer limits
- Contains no mercury or lead and RoHS compliant
- Photometric testing in accordance with IES LM-79-08
- Lumen maintenance projections in accordance with IES LM-80-08 and TM-21-11
- Can be used for State of California Title 24 high efficacy luminaire compliance. Complies with Title 24 JA8-2016-E.
- Can be used International Energy Conservation Code (IECC) high efficiency luminaire compliance.
- ENERGY STAR® listed, reference database for current listings

Warranty

- Five year limited warranty, consult website for details. www.eaton.com/lighting/legal

Photometric Data

[View IES files](#)

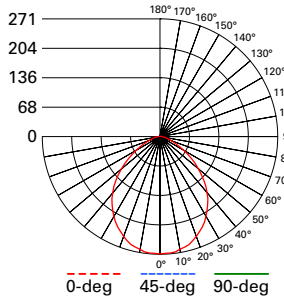

RL4069S1EWHR-3000K
 Spacing criterion: (0-180) 1.18
 (90-270) 1.18
 (Diagonal) 1.26
 Beam Angle: 93.1°
 Field Angle: 141.1°
 Lumens: 575
 Input Watts: 7.6 W
 Efficacy: 75.7 LPW
 Test Report:
 RL4069S1EWHR-3000K.ies

Zonal Lumen	Lumens	% Lumens
0-30	203	35.3
0-40	322	56
0-60	511	88.8
0-90	575	100

TM-30-15	Rf = 91.1
	Rg = 100.9
CRI/CIE	Ra = 93.1
	R9 = 64.9

CCT - Range of 2700K- 5000K



93°

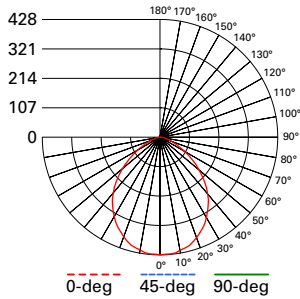

RL4099S1EWHR-3000K
 Spacing criterion: (0-180) 1.17
 (90-270) 1.17
 (Diagonal) 1.25
 Beam Angle: 93°
 Field Angle: 141.1°
 Lumens: 915
 Input Watts: 11.7 W
 Efficacy: 78.2 LPW
 Test Report:
 RL4099S1EWHR-3000K.ies

Zonal Lumen	Lumens	% Lumens
0-30	323	35.3
0-40	512	56
0-60	813	88.8
0-90	915	100

TM-30-15	Rf = 91.1
	Rg = 100.9
CRI/CIE	Ra = 93.1
	R9 = 64.9

CCT - Range of 2700K- 5000K



93°

Energy and Performance Data

RL4069S1EWHR	
Max. Lumens	621 @ 4000K
Input Voltage	120V
Input Frequency	50/60 Hz
Input Power	7.6W
Input Current	0.075A - 0.0875A (Per input power)
Power Factor	>0.90
THD	<20%
EMI/RFI	FCC Title 47 CFR, Part 15, Class B (Consumer)
Sound Rating	Class A
Minimum Starting Temp	-30°C (-22°F)

RL4099S1EWHR	
Max. Lumens	1006 @ 5000K
Input Voltage	120V
Input Frequency	50/60 Hz
Input Power	11.7W
Input Current	0.075A - 0.0875A (Per input power)
Power Factor	>0.90
THD	<20%
EMI/RFI	FCC Title 47 CFR, Part 15, Class B (Consumer)
Sound Rating	Class A
Minimum Starting Temp	-30°C (-22°F)

Tested in accordance with IES LM63. Field results may vary.

Note: Refer to IES files for more product data.

Photometric Data

[View IES files](#)

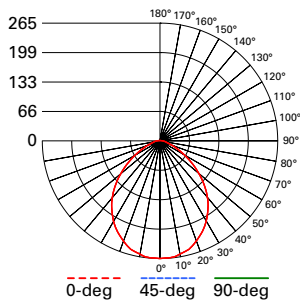

RL4069S1EWHR-CA-3000K
 Spacing criterion: (0-180) 1.17
 (90-270) 1.17
 (Diagonal) 1.25
 Beam Angle: 93.1°
 Field Angle: 141.1°
 Lumens: 576
 Input Watts: 6.3 W
 Efficacy: 91.4 LPW
 Test Report:
 RL4069S1EWHR-CA-3000K.ies

Zonal Lumen	Lumens	% Lumens
0-30	203	35.3
0-40	322	56
0-60	511	88.8
0-90	576	100

TM-30-15	Rf = 91.1
	Rg = 100.9
CRI/CIE	Ra = 93.1
	R9 = 64.9

CCT - Range of 2700K- 5000K

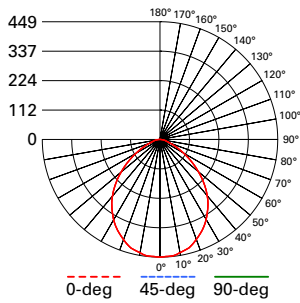
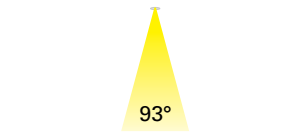

RL4099S1EWHR-CA-3000K
 Spacing criterion: (0-180) 1.17
 (90-270) 1.17
 (Diagonal) 1.25
 Beam Angle: 93°
 Field Angle: 141.1°
 Lumens: 967
 Input Watts: 9.9 W
 Efficacy: 97.7 LPW
 Test Report:
 RL4099S1EWHR-CA-3000K.ies

Zonal Lumen	Lumens	% Lumens
0-30	341	35.3
0-40	542	56
0-60	859	88.8
0-90	967	100

TM-30-15	Rf = 91.1
	Rg = 100.9
CRI/CIE	Ra = 93.1
	R9 = 64.9

CCT - Range of 2700K- 5000K

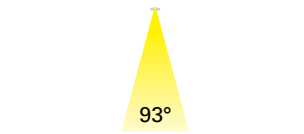

Energy and Performance Data

RL4069S1EWHR-CA	
Max. Lumens	590 @ 4000K
Input Voltage	120V
Input Frequency	50/60 Hz
Input Power	6.3W
Input Current	0.075A - 0.0875A (Per input power)
Power Factor	>0.90
THD	<20%
EMI/RFI	FCC Title 47 CFR, Part 15, Class B (Consumer)
Sound Rating	Class A
Minimum Starting Temp	-30°C (-22°F)

RL4099S1EWHR-CA	
Max. Lumens	992 @ 5000K
Input Voltage	120V
Input Frequency	50/60 Hz
Input Power	9.8W
Input Current	0.075A - 0.0875A (Per input power)
Power Factor	>0.90
THD	<20%
EMI/RFI	FCC Title 47 CFR, Part 15, Class B (Consumer)
Sound Rating	Class A
Minimum Starting Temp	-30°C (-22°F)