

# HALO OUTDOOR™

## DESCRIPTION

The HALO LED Die Cast floodlight series utilizes selectable CCT functionality, advanced two-stage optics and multiple mounting options for a versatile outdoor lighting solution. Multiple lumen packages and integrated control options address a wide range of outdoor general lighting and security applications. The durable die-cast aluminum housing is available in bronze or white powder coat finish, ensuring years of reliable, maintenance-free operation.

|                    |  |             |
|--------------------|--|-------------|
| <b>Catalog #</b>   |  | <b>Type</b> |
| <b>Project</b>     |  |             |
| <b>Comments</b>    |  | <b>Date</b> |
| <b>Prepared by</b> |  |             |

## SPECIFICATION FEATURES

### Construction

- Durable die-cast aluminum housing with UV stable clear lens
- Powder coated bronze or white finish
- Optically enhanced reflector improves efficiency and delivered lumens
- Tool-less head and motion sensor adjustment
- Wall or eave mounted to recessed or surface junction boxes

### Optics

- Two-stage optics for maximum coverage
- Field selectable CCT: 3000K, 4000K and 5000K

### Electrical

- 120VAC, 60Hz (Select SKUs)
- 120-277VAC, 60Hz (Select SKUs)
- Maintenance-free LEDs with 70,000 hours of life
- Fixture operating temperature of -30°C to 40°C
- External supply wiring 75°C minimum
- Integral photocell allows for nighttime ON / daytime OFF operation (Integrated sensor SKUs only)

### Select Motion SKUs

- Motion sensor detects motion 180° or 270° up to 50 feet
- Selectable duration to keep floodlights on up to 12 minutes
- Adjustable sensitivity
- Integral photocell prevents lights from turning on with motion during daylight hours
- Manual override allows fixture to operate as a standard dusk-to-dawn for up to 6 hours

### Warranty

- Five year limited warranty, consult website for details. [www.cooperlighting.com](http://www.cooperlighting.com)

### Compliance

- UL certified for US and Canada for wet locations
- EMI/RFI emissions per FCC 47CFR Part 15B
- Contains no mercury or lead and RoHS compliant.
- Photometric testing in accordance with IES LM-79-08
- Lumen maintenance projections in accordance with IES LM-80-08 and TM-21-11



## DIE CAST FLOOD SERIES SINGLE, TWIN, TRIPLE FLOODS

seleCCTable™

Suitable for recessed or surface mount electrical junction boxes

## DIMENSIONS

### FSL303T and FSL203T

Front View

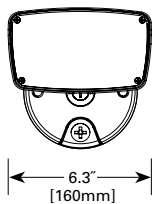

Side View

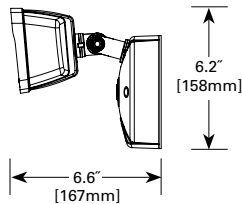

Wall Mount

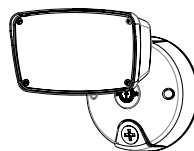

Eave Mount



### FSS153T

Front View

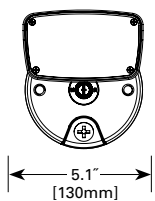

Side View

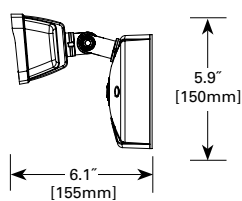

Wall Mount

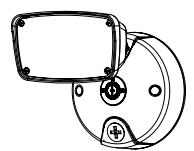

Eave Mount

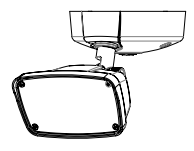

**DIMENSIONS**

**MST203T**

Front View

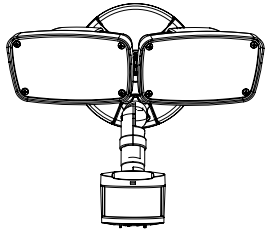
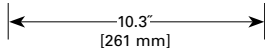

Side View

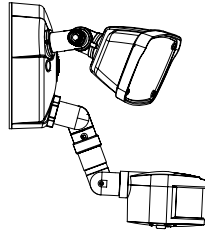
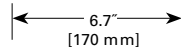

**MHS303T**

Front View

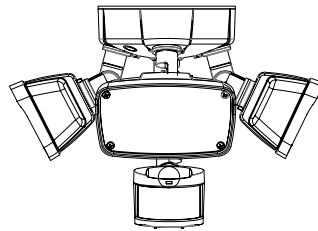
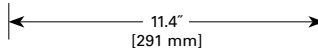

Side View

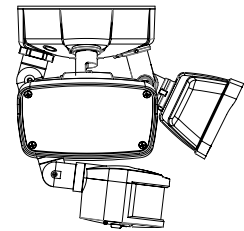
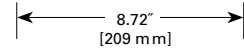

**ORDERING INFORMATION**

Sample Number: FSS153TIB or MST203T18W

| Module   | Lumens  | CRI/CCT   | Options   | Colors           |
|--|---|---|---|------------------|
| <b>FSS</b> = Flood Single Small<br><b>FSL</b> = Single Large Flood<br><b>FTS</b> = Flood Twin Small<br><b>FHS</b> = Flood Triple Small<br><b>MSS</b> = Motion Small Single<br><b>MST</b> = Motion Small Twin<br><b>MSH</b> = Motion Small Triple | <b>15</b> = 1500 lumens (nominal)<br><b>20</b> = 2000 lumens (nominal)<br><b>30</b> = 3000 lumens (nominal) | <b>3T</b> = Selectable CCT<br>3000K, 4000K, & 5000K | <b>I</b> = Integrated Photocell<br><b>18</b> = 180° Motion Sensor<br><b>27</b> = 270° Motion Sensor | <b>W</b> = White |

**PHOTOMETRY**

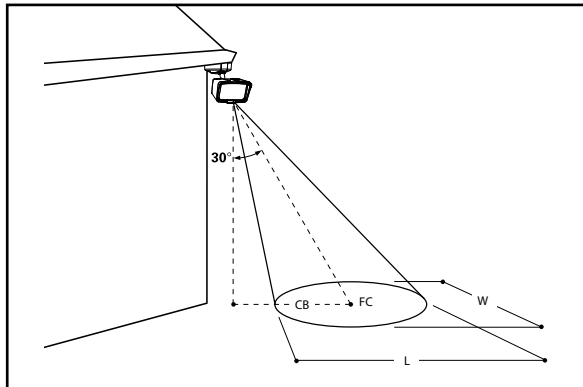

**Area Coverage**

|                       | Mounting Height | Length (L) | Width (W) | Area (Sq. Ft.) | Max FC |
|-----------------------|-----------------|------------|-----------|----------------|--------|
| <b>MST203T Series</b> | 10 ft.          | 18         | 40        | 720            | 4.3    |
|                       | 15 ft.          | 20         | 40        | 800            | 1.9    |
|                       | 20 ft.          | 20         | 40        | 800            | 1.1    |

Note: Bronze fixture at a typical mounting angle of 30° from vertical  
All figures based on minimum footcandle (FC) of 0.5 and 4000K CCT.

Note: Specifications and Dimensions subject to change without notice.

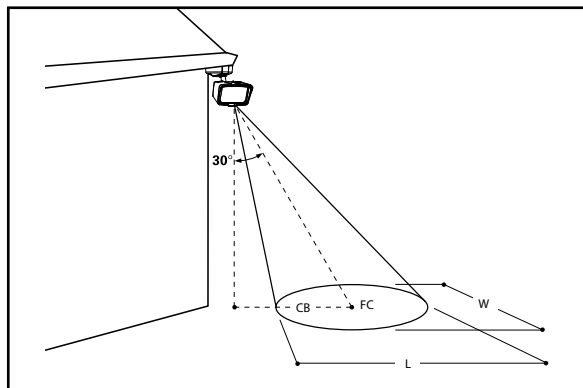

**Area Coverage**

|                       | Mounting Height | Length (L) | Width (W) | Area (Sq. Ft.) |
|-----------------------|-----------------|------------|-----------|----------------|
| <b>FSL303T Series</b> | 10 ft.          | 22         | 38        | 800            |
|                       | 15 ft.          | 28         | 42        | 1150           |
|                       | 20 ft.          | 32         | 50        | 1500           |
|                       | 25 ft.          | 35         | 56        | 1800           |
| <b>FSL203T Series</b> | 10 ft.          | 20         | 30        | 600            |
|                       | 15 ft.          | 24         | 40        | 960            |
|                       | 20 ft.          | 27         | 40        | 1040           |
| <b>FSS153T Series</b> | 10 ft.          | 20         | 25        | 400            |
|                       | 15 ft.          | 20         | 30        | 500            |
|                       | 20 ft.          | 22         | 35        | 560            |

Note: Bronze fixture at a typical mounting angle of 30° from vertical  
All figures based on minimum footcandle (FC) of 0.5.

**PHOTOMETRY**

| Series     | Voltage  | Power (W) | Delivered Lumens (Lm) | Efficacy (Lm/W) | CCT               | CRI | Controls             |
|------------|----------|-----------|-----------------------|-----------------|-------------------|-----|----------------------|
| FSS153TB   | 120-277V | 17.3      | 1503                  | 86.9            | 3000K,4000K,5000K | 84  | None                 |
| FSS153TW   | 120-277V | 17.3      | 1503                  | 86.9            | 3000K,4000K,5000K | 84  | None                 |
| FSS153TIB  | 120V     | 17.3      | 1503                  | 86.9            | 3000K,4000K,5000K | 84  | Integrated Photocell |
| FSS153TIW  | 120V     | 17.3      | 1503                  | 86.9            | 3000K,4000K,5000K | 84  | Integrated Photocell |
| FSL203TB   | 120-277V | 22.5      | 1916                  | 85.2            | 3000K,4000K,5000K | 84  | None                 |
| FSL203TW   | 120-277V | 22.5      | 1916                  | 85.2            | 3000K,4000K,5000K | 84  | None                 |
| FSL203TIB  | 120V     | 22.5      | 1916                  | 85.2            | 3000K,4000K,5000K | 84  | Integrated Photocell |
| FSL203TIW  | 120V     | 22.5      | 1916                  | 85.2            | 3000K,4000K,5000K | 84  | Integrated Photocell |
| FSL303TB   | 120-277V | 31.6      | 2900                  | 91.8            | 3000K,4000K,5000K | 84  | None                 |
| FSL303TW   | 120-277V | 31.6      | 2900                  | 91.8            | 3000K,4000K,5000K | 84  | None                 |
| FSL303TIB  | 120V     | 31.6      | 2900                  | 91.8            | 3000K,4000K,5000K | 84  | Integrated Photocell |
| FSL303TIW  | 120V     | 31.6      | 2900                  | 91.8            | 3000K,4000K,5000K | 84  | Integrated Photocell |
| FTS203TB   | 120-277V | 22.8      | 2034                  | 89.2            | 3000K,4000K,5000K | 84  | None                 |
| FTS203TW   | 120-277V | 22.8      | 2034                  | 89.2            | 3000K,4000K,5000K | 84  | None                 |
| FHS303TB   | 120-277V | 31.8      | 2853                  | 89.7            | 3000K,4000K,5000K | 84  | None                 |
| FHS303TW   | 120-277V | 31.8      | 2853                  | 89.7            | 3000K,4000K,5000K | 84  | None                 |
| MSH303T18B | 120V     | 31.8      | 2853                  | 89.7            | 3000K,4000K,5000K | 84  | 180* Motion Sensor   |
| MSH303T18W | 120V     | 31.8      | 2853                  | 89.7            | 3000K,4000K,5000K | 84  | 180* Motion Sensor   |
| MSS153T18B | 120V     | 17.3      | 1503                  | 86.9            | 3000K,4000K,5000K | 84  | 180* Motion Sensor   |
| MSS153T18W | 120V     | 17.3      | 1503                  | 86.9            | 3000K,4000K,5000K | 84  | 180* Motion Sensor   |
| MST203T18B | 120V     | 22.8      | 2034                  | 89.2            | 3000K,4000K,5000K | 84  | 180* Motion Sensor   |
| MST203T18W | 120V     | 22.8      | 2034                  | 89.2            | 3000K,4000K,5000K | 84  | 180* Motion Sensor   |
| MST203T27B | 120V     | 22.8      | 2034                  | 89.2            | 3000K,4000K,5000K | 84  | 270* Motion Sensor   |
| MST203T27W | 120V     | 22.8      | 2034                  | 89.2            | 3000K,4000K,5000K | 84  | 270* Motion Sensor   |