

UCM2-LK UPGRADE KIT INSTALLATION INSTRUCTIONS

! **WARNING:** Fixtures must be grounded in accordance with local codes or the National Electrical Code. Failure to do so may result in serious personal injury. **SEE BACK PAGE FOR ADDITIONAL SAFETY WARNINGS AND CAUTIONS.**

! **AVERTISSEMENT:** Les appareils doivent être mis à la terre conformément aux codes locaux ou au Code national de l'électricité. Ne pas le faire peut entraîner des blessures graves. **Reportez-vous à la page précédente pour obtenir des avertissements et des mises en garde supplémentaires.**

MAINTENANCE INSTRUCTIONS: **!** Make certain electricity is off before beginning maintenance procedures.

INSTRUCTIONS D'ENTRETIEN: **!** Assurez-vous que l'électricité est éteinte avant de commencer les procédures d'entretien.

1. For opening and closing of the fixture, refer to instructions and diagrams on instructions.
2. A regularly scheduled maintenance program should be established to retain optimum light output and reduce heat retention. Dusting with a soft, clean, dry cloth is normally sufficient for the optics.

Do not use alkaline or acid cleaners on reflector surfaces.

NOTE: All wiring must be done by a qualified electrician.

KEEP THIS SHEET FOR FUTURE REFERENCE.

Parts Required:

- (1) LED Deck Assembly
- (1) Driver Assembly
- (4) 1/4-20 Screws with O-rings
- (2) 8-32 Screws

Tool Required:

- Philip Head Screwdriver
- 5/32 Allen Wrench

STEPS:

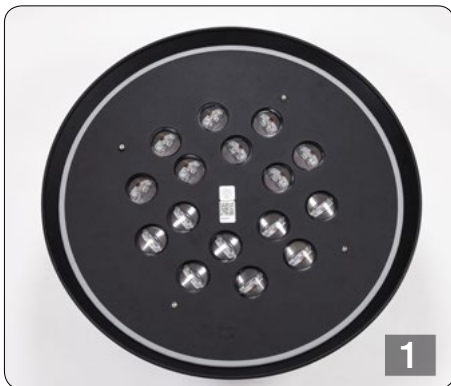

Turn off all power to existing fixture.



Remove (4) existing screws as shown. Discard screws. Pull out existing LED deck.

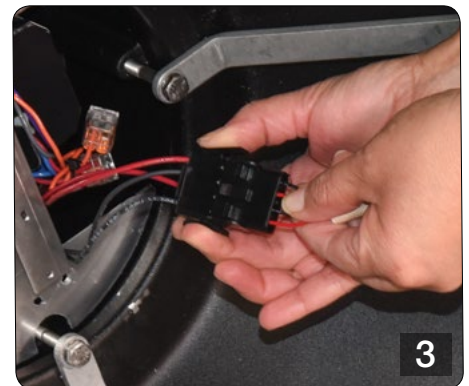

Disconnect existing wire harness.

UCM2-LK UPGRADE KIT INSTALLATION INSTRUCTIONS



Remove (2) screws from driver tray as shown.



Pull existing driver tray from fixture.

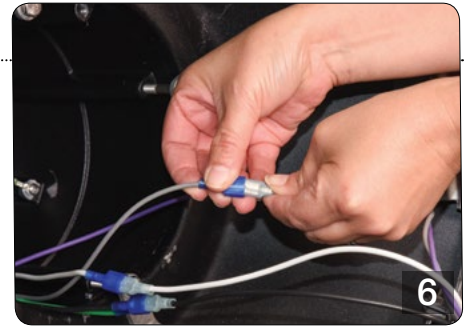

Disconnect all wires coming from arm as shown. Remove and discard existing driver assembly.



Connect wires from new driver assembly, Make sure to follow wire polarity i.e. green to green, white to white etc. Tuck leads into driver housing (make sure not to pinch wires).

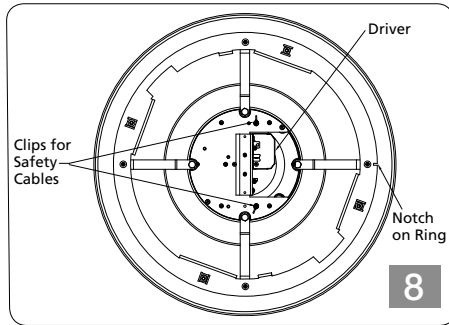

Rotate driver assembly to make sure it lines up as shown in the diagram.



Install new driver assembly back and secure in place using provided screws (hand tighten).



Attached (2) safety cables from new Deck Assembly. As shown.

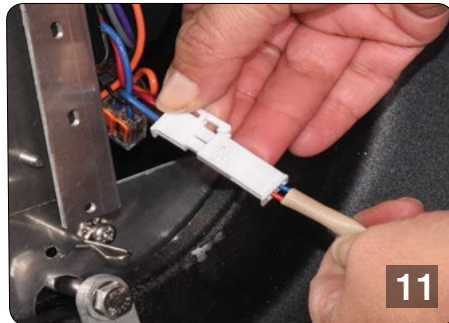

Make wire harness connection from driver assembly to Deck assembly as shown.

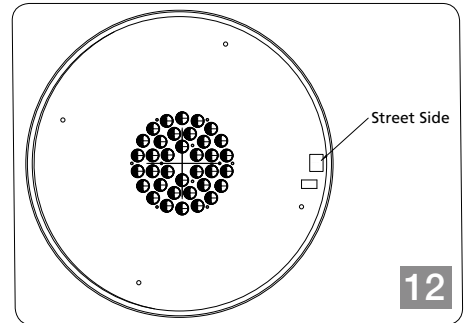

Align Deck assembly as shown, make sure street side label is pointing towards the correct direction.



Using new 1/4-20 Screws and O-rings, attach new deck assembly to housing. Torque screws to 48 in lbs.

















Installation is complete.











Architectural Area Lighting
17760 Rowland St, Rowland Heights, CA 91748 T
626.968.5666 | F 626.369.2695 |
currentlighting.com/aal

Installation warnings and cautions for upgrade kits

Avertissements et précautions pour l'installation de kits de mise à niveau.

-  **WARNING:** Make certain all electrical supply is OFF before starting installation or beginning maintenance procedures.
-  **AVERTISSEMENT:** S'assurer que toute alimentation possible est COUPÉE avant de commencer l'installation ou l'entretien.
-  **WARNING:** Fixtures must be grounded in accordance with local codes or the National Electrical Code. Failure to do so may result in serious personal injury.
-  **AVERTISSEMENT:** Les appareils doivent être mis à la terre en conformité avec le Code canadien de l'électricité et les codes locaux. Une non-conformité pourrait conduire à des blessures graves.
-  **WARNING:** To prevent wiring damage or abrasion, do not expose wiring to edges of sheet metal or other sharp objects.
-  **AVERTISSEMENT:** Pour empêcher l'endommagement ou l'éraflure des fils, empêchez tout contact avec les rebords des parties métalliques.
-  **MAINTENANCE:** A regularly scheduled maintenance program should be established to retain optimum light output and reduce heat retention. Dusting with a soft, clean, dry cloth is normally sufficient for the reflector.
-  **ENTRETIEN:** Un programme d'entretien régulier devrait être établi pour conserver la luminosité optimale et réduire l'accumulation de chaleur. Un chiffon doux et propre est normalement suffisant pour dépolir le réflecteur optique.
-  **NOTE:** All wiring must be done by a qualified electrician.
-  **REMARQUE:** Tout le câblage doit être fait par un électricien certifié.
-  **CAUTION:** LED fixtures are available in 120 volt input or 277volt input. Please verify before wiring fixture to field wires. (see lamp label to verify).
-  **MISE EN GARDE:** Les appareils d'éclairage à DEL sont offerts pour alimentation à 120 V ou 277 V. Veuillez vérifier avant de raccorder (voir l'étiquette de l'appareil pour confirmer).
-  **WARNING: RISK OF FIRE OR ELECTRICAL SHOCK.** Install this kit only in the luminaires that have the construction features and dimensions shown in the photographs and/or drawings. Luminaires wiring, power supply, or other electrical parts may be damaged when drilling for installation of retrofit assembly hardware. Inspect all wiring and components for damage, and replace any damaged parts prior to installation of upgrade kit.
-  **AVERTISSEMENT: DANGER DE CHOC ÉLECTRIQUE OU D'INCENDIE.** Installez ce kit dans les luminaires qui ont les caractéristiques de construction et les dimensions indiquées dans les photographies et / ou dessins. Câblage des luminaires,

alimentation, ou d'autres pièces électriques peuvent être endommagés lors du forage pour l'installation du matériel de montage de rénovation. Vérifiez tout le câblage et les composants pour les dommages, et remplacer les pièces endommagées avant l'installation du kit de mise à niveau.

-  **CAUTION:** Unless otherwise specified, do not make or alter any openings in the compartment of wiring or electrical components during installation of this retrofit assembly. Plug all unused openings in the compartment of wiring or electrical components.
-  **ATTENTION:** Pour cette modification, ne pas percer ou modifier toute ouverture du compartiment de connexion des câbles ou celui des composants électriques sauf si clairement indiqué dans une autre directive. Bouchez toutes les ouvertures du compartiment de connexion ou des composants électriques qui ne sont pas utilisées.
-  **CAUTION:** Only the holes indicated in the photographs and/or drawings may be made or altered as a result of kit installation. Do not leave any other open holes in an enclosure of wiring or electrical components.
-  **ATTENTION:** Seuls les trous indiqués dans les photographies et/ou les dessins peuvent être percés ou modifiés pour installer la présente tousse. Les compartiments de connexion ou des composants électriques ne doivent comprendre aucune ouverture non obstruée autre que celles requises au câblage.
-  **CAUTION:** Installation of this retrofit assembly requires a person familiar with the construction and operation of LED luminaire electrical systems and the hazards involved
-  **ATTENTION:** installation de ce nécessaire de modernisation a une personne connaissant la construction et le fonctionnement des installations d'éclairage fluorescent et consciente des risques qu'elles comportent.
-  **CAUTION:** Do not alter, relocate, or remove wiring, lampholders, ballasts, or any other electrical components.
-  **ATTENTION:** Ne pas modifier, déplacer ni enlever de câble, de douille de lampe, de ballast ou autre composant électrique.
-  **WARNING:** The H.I.D./Fluorescent fixtures utilizes a lamp that may contain mercury. For information on disposal of lamp go to website: www.lamprecycle.org.
-  **AVERTISSEMENT:** Les appareils d'éclairage à décharge à haute intensité ou à fluorescents peuvent contenir du mercure. Pour l'information de disposition des ampoules/tubes, visitez le site Web: www.lamprecycle.org.
- CONSERVER LA PRÉSENTE FEUILLE POUR RÉFÉRENCE ULTÉRIEURE.**
- KEEP THIS SHEET FOR FUTURE REFERENCE.**

For warranty see currentlighting.com