

LED

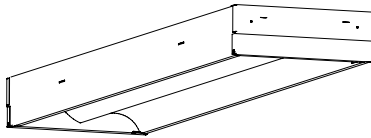

createchange

FEATURES

- High-performance LED luminaire
- Long-life, 60,000 hour LEDs at L80 (80% lumen maintenance) reduce life cycle maintenance costs
- DesignLights Consortium® qualified
- Four LED color choices
- Four lumen packages ranging from 4100 to 6725 nominal
- Superior color consistency to a 3-step MacAdam ellipse and 82 CRI
- Full distribution provides controlled high angle light for visual comfort
- Lens design and materials provide uniform appearance without pixilation
- Unique frameless optical system and modular electrical system allow for easy LED module or driver replacement from below the ceiling
- Most configurations produce low W/ft² to meet the most restrictive lighting power density codes
- U.S. Transformed

PROJECT INFORMATION

Project Name _____

Type _____

Catalog No. _____

Date _____

CONSTRUCTION

Luminaire housing, end caps, and reflectors are die-formed code-gauge cold-rolled steel. Frameless optics system hinges from either side for easy access to lamps and electrical components. Mechanical light trap prevents light leaks. Latches are spring loaded.

FINISH

All visible parts are custom formulated soft, non-glare high-reflectance white powder coat finish, painted after fabrication.

SHIELDING

Lenses are high transmission extruded acrylic.

INSTALLATION

An access plate is furnished with each recessed fixture for fast wiring connections without the necessity to open the fixture or wireway.

CEILING COMPATIBILITY

Luminaire fits recessed exposed grid ceilings (G); four integral T-Bar clips standard. A flange kit (FK) option is available for recessed hard ceiling applications. Surface Mount (SM) option allows placement on ceiling plane. Cable Mount option (CM) allows suspension below ceiling plane. For information on compatibility with specific ceilings, or where plenum depth is a problem, contact your Hubbell Lighting representative.

CERTIFICATION

All luminaires are built to UL1598 and 2108 standards, and bear appropriate CSA labels. Damp location labeling is standard. Emergency equipped fixtures labeled UL924. Adheres to LM79, LM80 and TM21 standards. IC rating is standard on all models. Designlights Consortium® (DLC) qualified. Please refer to the DLC website for specific product qualifications at www.designlights.org. UL Sanitation Approved.

WARRANTY

Five year warranty. (Terms and Conditions apply)

ORDERING INFORMATION

EXAMPLE LEPC14-35HLG-LL-EDU

LEPC 14 -		- LL -		- U -			
MODEL	COLOR TEMP	CEILING TYPE	AIR FUNCTION	DRIVER	VOLTAGE	OPTIONS	
LEPC e-poc® LED Full Distribution Luminaire	30 3000K 35 3500K 40 4000K 50 5000K	G Grid SM Surface Mount For hard ceilings use flange kit.	Blank Static	E Fixed Output ED 0-10V Dimming ESD Fixed Output / Step Dimming ⁴	U 120V-277V	C388 3-Wire Flex C488 4-Wire Flex C588 5-Wire Flex GLR Fast Blow Fuse NYC NYC Compliant NYCU NYC Compliant, Union Label RM Row Mount ELL14 Emergency Battery Pack Installed, 1400 Lumens ³ CP Chicago Plenum	
SIZE	LUMEN OUTPUT	SHIELDING					
14 1' x 4'	LW Low Watt ML Medium Lumen HL High Lumen VL Very High Lumen (See Product Availability Table Below)	LL Low Lamp Image					

ACCESSORIES (ORDER SEPARATELY)

- FK14 1' x 4' Single Flange Kit
- FKCR Flange Kit Row Adaptor

PRODUCT AVAILABILITY

SIZE	LUMEN PACKAGE	NOMINAL LUMENS (4000K)	NOMINAL WATTS	LUMENS PER WATT
1'x4'	LW	4100	35	116
	ML	4950	44	114
	HL	5450	49	112
	VL	6725	62	108

Actual lumens will vary according to color temperature and other factors. For exact lumens and watts see specific photometric test(s).

¹In-Fixture Module Antenna adds 2" to overall height at specific location.

²Not available with Surface Mount ceiling types.

³For compatibility with Dual-Lite Lite Gear® inverters in lieu of installed Battery Pack, contact Hubbell Lighting Representative

⁴Can be converted to fixed output by tying the hot leads together.

Damp Label - standard

IC Rating - standard

Protected by US Patents D593,246; D617,487.
Additional US and Canada Patents Pending.
Specifications subject to change without notice.

PHOTOMETRIC DATA

LUMINAIRE DATA

Luminaire	LEPC14-40LWG-LL-EDU LEPC Epoc LED Full Distribution, Recessed Architectural 1 x 4 LED with frosted linear prisms lenses
Ballast	D10CC55UNVTC
Ballast Factor	1.00
Lamp	LED
Fixture Lumens	4099
Watts	35.30
Shielding Angle	0° = 90 90° = 90
Spacing Criterion	0° = 1.19 90° = 1.24
Luminous Opening in Feet	Length: 3.88 Width: 0.83 Height: 0.00

ZONAL LUMEN SUMMARY

Zone	Lumens	% Lamp	% Fixt.
0-30	1171	28.6	28.6
0-40	1899	46.3	46.3
0-60	3303	80.6	80.6
0-90	4099	100.0	100.0
0-180	4099	100.0	100.0

ENERGY DATA

Total Luminaire Efficiency	100.0%
Total Lumens per Watt	116
ANSI/IESNA RP-1-2004 COMPLIANCE	Noncompliant
Comparative Yearly Lighting Energy Cost per 1000 Lumens	\$2.05 based on 3000 hrs. and \$0.08 per KWH

Test 14.00550 Test Date 10/20/2014

INDOOR CANDELA PLOT

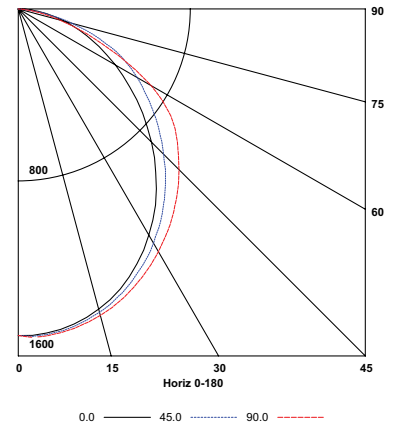

LUMINAIRE DATA

Luminaire	LEPC14-40MLG-LL-EDU LEPC Epoc LED Full Distribution, Recessed Architectural 1 x 4 LED with frosted linear prisms lenses
Ballast	D10CC55UNVTC
Ballast Factor	1.00
Lamp	LED
Fixture Lumens	4958
Watts	43.50
Shielding Angle	0° = 90 90° = 90
Spacing Criterion	0° = 1.19 90° = 1.27
Luminous Opening in Feet	Length: 3.88 Width: 0.83 Height: 0.00

ZONAL LUMEN SUMMARY

Zone	Lumens	% Lamp	% Fixt.
0-30	1416	28.6	28.6
0-40	2296	46.3	46.3
0-60	3995	80.6	80.6
0-90	4958	100.0	100.0
0-180	4958	100.0	100.0

ENERGY DATA

Total Luminaire Efficiency	100.0%
Total Lumens per Watt	114
ANSI/IESNA RP-1-2004 COMPLIANCE	Noncompliant
Comparative Yearly Lighting Energy Cost per 1000 Lumens	\$2.12 based on 3000 hrs. and \$0.08 per KWH

Test 14.00549 Test Date 10/20/2014

INDOOR CANDELA PLOT

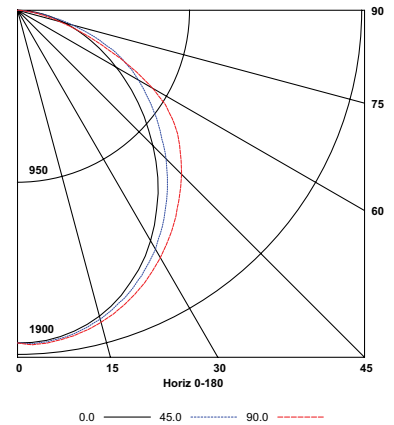

LUMINAIRE DATA

Luminaire	LEPC14-40HLG-LL-EDU LEPC Epoc LED Full Distribution, Recessed Architectural 1 x 4 LED with frosted linear prisms lenses
Ballast	D10CC55UNVTC
Ballast Factor	1.00
Lamp	LED
Fixture Lumens	5452
Watts	48.50
Shielding Angle	0° = 90 90° = 90
Spacing Criterion	0° = 1.19 90° = 1.27
Luminous Opening in Feet	Length: 3.88 Width: 0.83 Height: 0.00

ZONAL LUMEN SUMMARY

Zone	Lumens	% Lamp	% Fixt.
0-30	1557	28.6	28.6
0-40	2525	46.3	46.3
0-60	4393	80.6	80.6
0-90	5452	100.0	100.0
0-180	5452	100.0	100.0

ENERGY DATA

Total Luminaire Efficiency	100.0%
Total Lumens per Watt	112
ANSI/IESNA RP-1-2004 COMPLIANCE	Noncompliant
Comparative Yearly Lighting Energy Cost per 1000 Lumens	\$2.11 based on 3000 hrs. and \$0.08 per KWH

Test 14.00548 Test Date 10/19/2014

INDOOR CANDELA PLOT

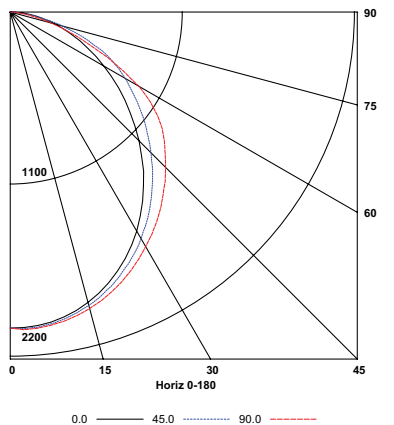

PHOTOMETRIC DATA

Test 14.00547 Test Date 10/19/2014

LUMINAIRE DATA

Luminaire	LEPC14-40VLG-LL-EDU LEPC Eloc LED Full Distribution, Recessed Architectural 1 x 4 LED with frosted linear prisms lenses
Ballast	D10CC55UNVTC
Ballast Factor	1.00
Lamp	LED
Fixture Lumens	6744
Watts	62.30
Shielding Angle	0° = 90 90° = 90
Spacing Criterion	0° = 1.19 90° = 1.27
Luminous Opening in Feet	Length: 3.88 Width: 0.83 Height: 0.00

ZONAL LUMEN SUMMARY

Zone	Lumens	% Lamp	% Fixt.
0-30	1925	28.5	28.5
0-40	3122	46.3	46.3
0-60	5433	80.6	80.6
0-90	6744	100.0	100.0
0-180	6744	100.0	100.0

ENERGY DATA

Total Luminaire Efficiency	100.0%
Total Lumens per Watt	108
ANSI/IESNA RP-1-2004 COMPLIANCE	Noncompliant
Comparative Yearly Lighting Energy Cost per 1000 Lumens	\$2.20 based on 3000 hrs. and \$0.08 per KWH

INDOOR CANDELA PLOT

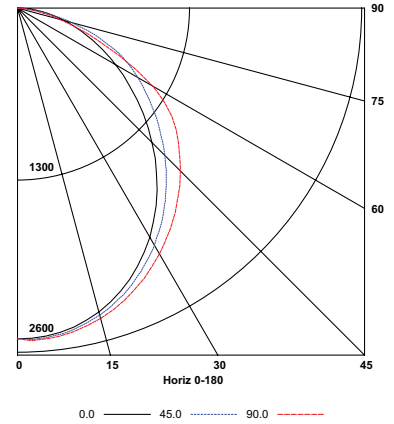

DIMENSIONAL DATA - GRID

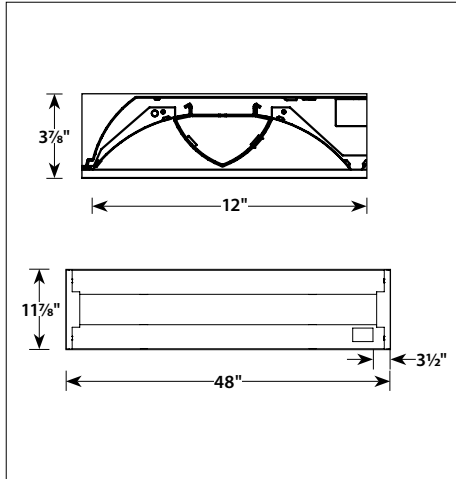

CEILING COMPATIBILITY

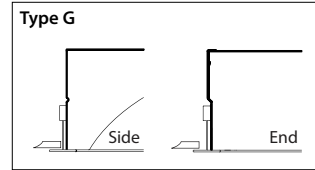

For lay-in installation in exposed grid ceilings. Maximum tee widths of 1" and maximum tee heights of 2" allowed.

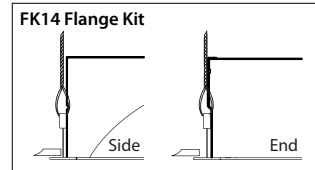

For hard ceiling applications, order FK14 flange kit. Flange kit wires directly into concealed ceiling opening for a clean, finished appearance.

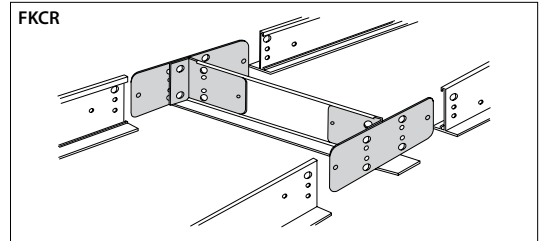

For flanged fixtures in row configurations, the FKCR adapter bracket kit is required in addition to the FK14 kit. Order one less FKCR than the total number of fixtures in row. (Example: Row of two, order (2) FK14 & (1) FKCR)

Row cut out dimensions using FK14s & FKCR adapters:
Width 12 3/8", Length [48" x (# in row)] + 3/8".
Example: (48" x 2) + 3/8" = 96 3/8"

Flange kit cut out dimension for single unit only: 12 3/8" x 48 3/8"

DIMENSIONAL DATA - SURFACE MOUNT

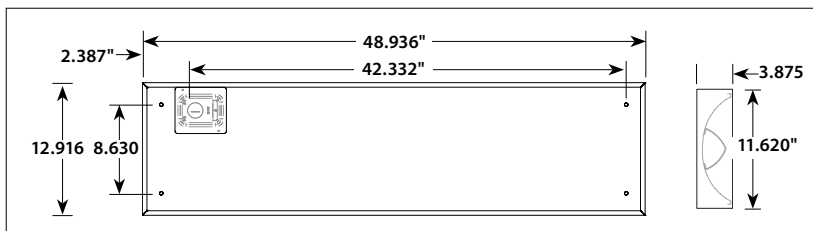

NOTE: All dimensions are in inches; dimensions and specifications are subject to change without notice. Please consult factory or check sample for verification.