



# 6" VERTICAL CFL WALL WASH

Project: \_\_\_\_\_

Fixture Type: \_\_\_\_\_

Location: \_\_\_\_\_

Contact/Phone: \_\_\_\_\_

OPEN APERTURE

One 18W Triple Tube

**CV6-118T-600C-WWS**

## PRODUCT SPECIFICATIONS

**Lamp** One 18W triple tube compact fluorescent lamp CFTR18W/GX24q-2 • 4 pin electronic.

**Socket Housing** Vented, extruded aluminum housing with heat dissipating fins • Single-position, keyed reflector attachment.

**Ballast** 120V thru 277V HPF Electronic with end-of-life lamp protection • 347V HPF Electronic available in Canada • U.L. listed/CSA certified.

**Reflector** .050" aluminum reflector in low iridescent clear Alzak® finish with cut-out and diffuse wall wash kicker reflector • Other finishes including wheat, straw, haze and pewter available on special order basis.

**Trim Ring** White Polycarbonate.

**Labels** U.L. listed for through branch wiring and damp locations • Union made • CSA certified.

**Testing** All reports are based on published industry procedures; field performance may differ from laboratory performance.

Product specifications subject to change without notice.

## INSTALLATION

**Mounting Bracket** Rough-in section equipped with vertically adjustable mounting brackets (up to 3") that accept 1/2" conduit or "C" channels (HB-26 or HB-50), linear flat bars (LB-27) or Real Nail® 3 bar hangers (HB-1).

**Junction Box** Pre-wired junction box provided with (5) 1/2" and (1) 3/4" knockouts, U.L. listed/CSA certified for through branch wiring, maximum 8 No. 12 AWG 90° C branch circuit conductors (4 in, 4 out) • Junction box provided with removable access plates • Knockouts equipped with pryout slots.

**Mounting Frame** 16-gauge galvanized steel mounting ring with factory installed reflector mounting clips • Rough-in section (junction box, mounting frame and socket assembly) fully assembled for ease of installation • Accommodates 7/8" ceiling thickness maximum.

## PRODUCT CODES

| Catalog Number              | Cut-Out | Reflector Finish           | Ballast                 | Wattage and Lamp    |
|-----------------------------|---------|----------------------------|-------------------------|---------------------|
| <b>CV6-118T-600C-WWS-WH</b> | Single  | Low Iridescent Clear Alzak | HPF 120V - 277V, Elect. | 18W Triple Tube CFL |

## DIMENSIONS

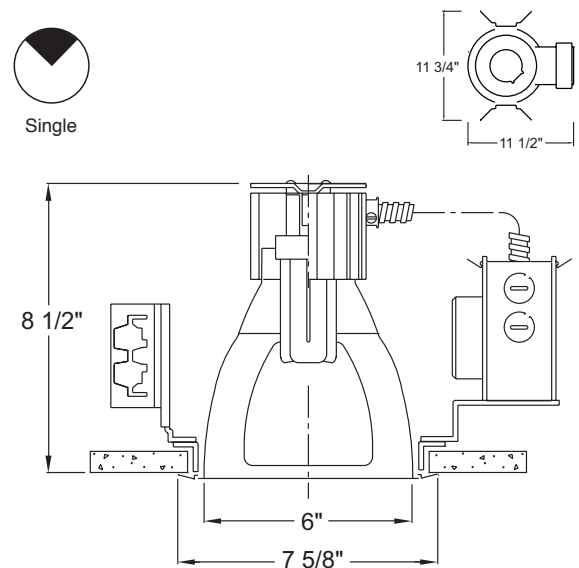

6 7/8" CEILING CUTOUT

## ENGINEERING DATA

|                           | 120V-HPF      | 277V-HPF      | 347V-HPF Canada |
|---------------------------|---------------|---------------|-----------------|
| Total input power         | 19W           | 19W           | 19W             |
| Operating AMPS            | .16A          | .07A          | .06A            |
| Power Factor              | >.98          | >.98          | >.98            |
| T.H.D.                    | <10%          | <10%          | <10%            |
| Min. starting temperature | 0°F/<br>-18°C | 0°F/<br>-18°C | 0°F/<br>-18°C   |
| Crest Factor              | <1.6          | <1.6          | <1.6            |
| Ballast Factor            | 1.00          | 1.00          | 1.00            |

## ACCESSORIES

| Catalog No.  | Description                                |
|--------------|--|
| <b>HB-26</b> | Two 26" C-channel bar hangers              |
| <b>HB-50</b> | Two 50" C-channel bar hangers              |
| <b>HB-1</b>  | Two 13 1/2" - 25" Real Nail® 3 bar hangers |
| <b>LB-27</b> | Two 27" linear bar hangers                 |
| <b>PLK-E</b> | 13-42W emerg. power kit (Elect. Ballast)   |

To order, specify catalog number.

## OPTIONS

(Add as suffix to housing or trim)

| Catalog No. | Description                  |
|-------------|------------------------------|
| <b>347</b>  | 347V, HPF Electronic Ballast |

Ordering Example: CV6-118T-~~347~~-600C-WWS

**PHOTOMETRIC REPORT**

**Test Report #:** PT04990310

**Catalog No:** CV6-118T-600C-WWS-WH

**Luminaire:** Recessed Single Cut-Out Wall Wash

**Lamp:** One 18W Triple Tube CFL lamp rated @ 1200 lumens









# 6" VERTICAL CFL WALL WASH

OPEN APERTURE

One 18W Triple Tube

## CV6-118T-600C-WWS

**FOOTCANDLES ON WALL FROM MULTIPLE FIXTURES**

| Fixture Distance to Wall |     | 2'   |  |   | 3'   |  |  |
|--------------------------|-----|--|--|---|--|--|--|
|                          |     |  2'  |  3'  |  3'  |  4'  |  |  |
| DISTANCE FROM CEILING    | 1'  | 6 7 6  | 5 5 5  | 2 2 2   | 2 2 2  |  |  |
|                          | 2'  | 22 26 22   | 17 19 17   | 7 8 7   | 6 6 6  |  |  |
|                          | 3'  | 22 24 22   | 16 16 16   | 12 12 12  | 9 10 9   |  |  |
|                          | 4'  | 21 21 21   | 14 14 14   | 11 11 11  | 8 9 8  |  |  |
|                          | 5'  | 18 18 18   | 12 12 12   | 10 10 10  | 8 8 8  |  |  |
|                          | 6'  | 14 15 14   | 10 10 10   | 10 10 10  | 7 8 7  |  |  |
|                          | 7'  | 12 12 12   | 8 8 8  | 9 9 9   | 7 7 7  |  |  |
|                          | 8'  | 10 10 10   | 7 7 7  | 8 8 8   | 6 6 6  |  |  |
|                          | 9'  | 9 9 9  | 6 6 6  | 7 7 7   | 6 6 6  |  |  |
|                          | 10' | 9 9 8  | 6 6 6  | 7 7 7   | 5 5 5  |  |  |

