



# BLACK BODY DIMMING & TUNABLE WHITE 700/1000 LUMEN ADJUSTABLE LED

3-1/4" SQUARE LENSED ANGLE CUT

**IC(9)43TSQ-431SQ, IC49TSQ-431SQ,  
TC(9)49TSQ-431SQ**



## PRODUCT DESCRIPTION

Recessed adjustable LED luminaire features both Black Body Dimming and Tunable White technology in a single fixture. In Black Body Dimming mode, the luminaire duplicates halogen dimming, creating a natural warm glow as the CCT shifts from 3000K to less than 1800K when dimmed. In Tunable White mode, the CCT can be adjusted anywhere along the Planckian locus from 2000K through 4350K independent of dimming. Aculux Black Body Dimming and Tunable White luminaires feature a sealed Air-Loc® housing and is available in both IC and Non-IC rated configurations.

## PRODUCT SPECIFICATIONS

**LED Light Engine** With single dimmer connected, the light engine duplicates halogen, with the CCT shifting from 3000K at 100% to 1800K when dimmed to 1% • Connect a second dimmer to engage Tunable White mode, featuring independent dimming and CCT tuning from 2000K through 4350K • Superb color consistency within 2 SDCM of the Planckian locus over CCT range • Accurate color rendition with 90 CRI at 3000K, and 85 CRI/70 R9 throughout CCT range.

**Dimming and CCT Control** Black Body Dimming and CCT Tuning are compatible with most 0-10V protocol dimmers • IC rated housings are rated for 120-277V input • For Non-IC housings, specify 120V or 277V. Refer to installation instructions for detailed wiring schematics.

**Modular Optics** Field interchangeable optics available with 21° Very Narrow Flood, 27° Narrow Flood, or 36° Flood distributions • 50° distribution is available when AF3-50DEG accessory lens is used with 27° Narrow Flood optic • Patent pending auto-adjusting optic holder maximizes luminaire efficiency by maintaining optimal LED optic position relative to trim • Accommodates up to three (3) beam control lenses and/or filters.

**Adjustability** Acu-Aim™ precision geared hot-aiming achieves 370° rotation, 45° tilt • Optimized center beam optics translates light engine forward as it is aimed off nadir

**Reflector** Lensed .040" aluminum angle-cut reflector in clear, gold, black, haze, or wheat haze Alzak finish provides 50° cut-off.

**Trims Style** Self Flanged and Flush Mount reflectors available • Flange is same finish as reflector unless optional painted white flange is specified • For flush mount installations in drywall ceilings use the FMASQ4 flush mount adapter • For flush mount installations in wood, stone, or tile ceilings the FMASQ4-SC\*\*\* must be used (specify ceiling thickness and adapter finish).

**Life** Rated for 50,000 hrs at 70% lumen maintenance.

**Warranty** 5 years from date of purchase on LED components • Standard Juno Lighting Group product guarantee terms and conditions apply.

**Codes/Labels** UL and cUL listed for through branch wiring, wet locations • Meets energy code Air Leakage requirements per ASTM E283 • Union made.

**Mounting** Available with either Patented (US Patent 8,038,113) Pro-VI™ bar hanger system, permitting quick placement of housing with 24" on-center joists or suspended ceilings, or with vertically adjustable mounting brackets (butterfly brackets). Specify mounting style when ordering.

**Junction Box** IC housings are rated for 4 No. 12 AWG 90°C through branch circuit conductors. • Non-IC housings are rated for 8 No. 12 AWG 90°C through branch circuit conductors. • Includes (5) 1/2", (1) 3/4", and (4) Non-metallic sheathed cable knock-outs. • Push-in electrical connectors for field connections.

**Housing/Mounting Frame** Housing painted black for visually dark interior • V-Notch in plaster frame and Patented (US Patent 8,277,090) Tru-Line™ Platform featuring +/- 1/2" translation and +/- 45° aperture rotation aids fixture alignment after installation, prior to drywall.

**Ceiling Thickness** 1/2" - 7/8" ceiling standard • For thicker ceilings, order CTA4SQ-125 (7/8"-1 1/4"), CTA4SQ-163 (1 1/4"-1 5/8") or CTA4SQ-200 (1 5/8"-2") • CTA4SQ not required for wood, stone, or tile flush mount applications.

## ELECTRICAL DATA

Housing	IC(9)43TSQ		IC49TSQ		TC(9)49TSQ	
Voltage	120	277	120	277	120	277
Input Power (W)	13.0	14.3	20.5	21.6	22.5	23.6
Input Current (A)	0.11	0.06	0.17	0.09	0.18	0.09
Frequency	50/60Hz		50/60Hz		50/60Hz	
Power Factor	0.99	0.92	0.99	0.92	0.99	0.92

REV-11/14

Type	Cat. No.
_____	_____
Project: _____	
Notes: _____	

## DIMENSIONS

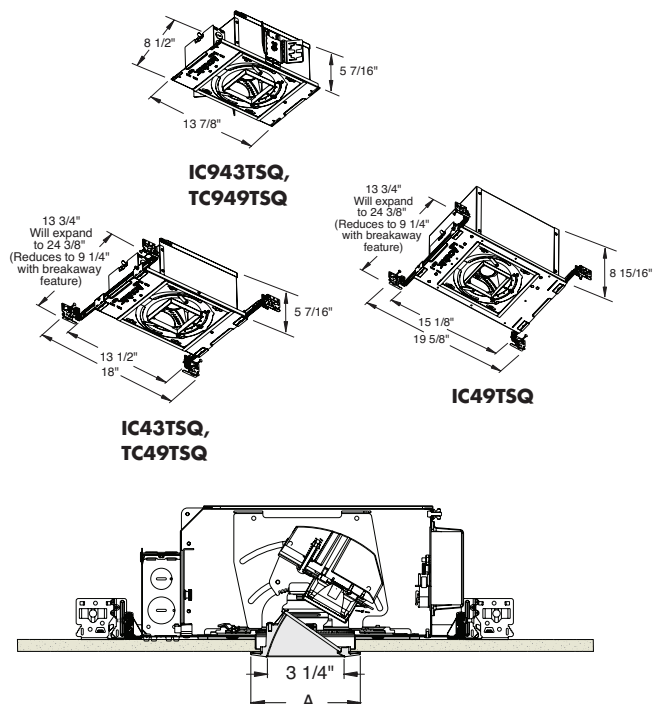

4 1/8" CEILING CUTOUT  
(REFER TO INSTRUCTION SHEET FOR  
FLUSH MOUNT CEILING CUTOUT)

	A
Self Flanged	4 1/2"
Flush Mount	3 5/8"

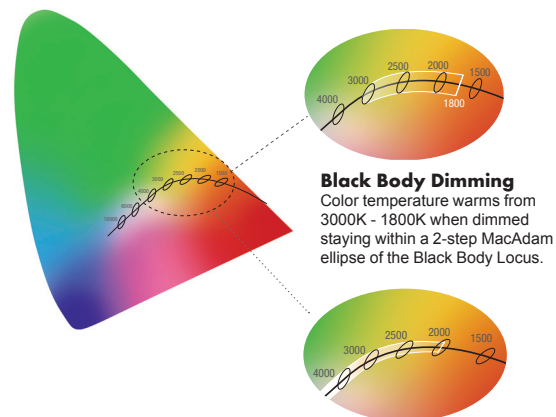

**Black Body Dimming**  
Color temperature warms from 3000K - 1800K when dimmed staying within a 2-step MacAdam ellipse of the Black Body Locus.

**Tunable White**  
Color temperature can be tuned from 4350K - 2000K while staying within a 2-step MacAdam ellipse of the Black Body Locus.



# BLACK BODY DIMMING & TUNABLE WHITE 700/1000 LUMEN ADJUSTABLE LED

3-1/4" SQUARE LENSED ANGLE CUT

**IC(9)43TSQ-431SQ, IC49TSQ-431SQ,  
TC(9)49TSQ-431SQ**

## Ordering Information



Housing, trim and accessories each ordered separately

Example: **TC949TSQ-W-N-U1**

Housing	Tunable White Range	Beam Spread	Voltage/Dimming <sup>1</sup>	Options
<input type="text"/>	<input type="text" value="W"/>	<input type="text"/>	<input type="text"/>	<input type="text"/>
<b>IC43TSQ</b> 700 Lumen, Bar Hangers (IC)	<b>W</b> 4350K - 2000K	<b>V</b> 21° Very Narrow Flood	<b>U</b> 120-277V, 0-10V Dimming	<b>CP*</b> Chicago Plenum
<b>IC943TSQ</b> 700 Lumen, Butterfly Brackets (IC)		<b>N</b> 27° Narrow Flood	<b>U1</b> 120V, 0-10V Dimming	
<b>IC49TSQ</b> 1000 Lumen, Bar Hangers (IC)		<b>F</b> 36° Flood	<b>U2</b> 277V, 0-10V Dimming	
<b>TC49TSQ</b> 1000 Lumen, Bar Hangers (Non-IC)				
<b>TC949TSQ</b> 1000 Lumen, Butterfly Brackets (Non-IC)				

\*Not available on IC49TSQ Housing.  
<sup>1</sup> IC is Universal voltage. Specify voltage for Non-IC products.

Example: **431SQW-SF**

Trim		
<input type="text"/>		
		
Self Flanged <sup>1</sup>	Flush Mount <sup>2</sup>	Description
<b>431SQBHZ-SF</b>	<b>431SQBHZ-FM</b>	Black Haze Reflector
<b>431SQHZ-SF</b>	<b>431SQHZ-FM</b>	Haze Reflector
<b>431SQW-SF</b>	<b>431SQW-FM</b>	White Reflector
<b>431SQWHZ-SF</b>	<b>431SQWHZ-FM</b>	Wheat Haze Reflector

<sup>1</sup>For self flanged reflector with optional white painted flange, replace "SF" suffix with "-SFWH".

<sup>2</sup>Flush Mount trims must be used with Flush Mount Adapter, ordered separately.

Product specifications subject to change without notice.

## Flush Mount Adapters

Cat. #	Description
<b>FMASQ4</b>	Drywall Ceiling Adapter
<b>FMASQ4-SC100-WH</b>	Wood, Stone, Tile, 1/2"-1" Thick Ceiling, Adapter, White
<b>FMASQ4-SC100-BL</b>	Wood, Stone, Tile, 1/2"-1" Thick Ceiling, Adapter, Black
<b>FMASQ4-SC138-WH</b>	Wood, Stone, Tile, 1"-1 3/8" Thick Ceiling, Adapter, White
<b>FMASQ4-SC138-BL</b>	Wood, Stone, Tile, 1"-1 3/8" Thick Ceiling, Adapter, Black
<b>FMASQ4-SC175-WH</b>	Wood, Stone, Tile, 1 3/8"-1 3/4" Thick Ceiling, Adapter, White
<b>FMASQ4-SC175-BL</b>	Wood, Stone, Tile, 1 3/8"-1 3/4" Thick Ceiling, Adapter, Black

## Optical Accessories

Cat. #	Description	Cat. #	Description
<b>TIR-TW-V</b>	21° Very Narrow Flood Optic	<b>T7403</b>	Med. Green Dichroic Lens
<b>TIR-TW-N</b>	27° Narrow Flood Optic	<b>T7404</b>	Med. Blue Dichroic Lens
<b>TIR-TW-F</b>	36° Flood Optic	<b>T7405</b>	Yellow Dichroic Lens
<b>AF3-50DEG</b>	50° Optic Film (Use with 27° Optic)	<b>T7406</b>	Magenta Dichroic Lens
<b>T741</b>	Med. Pink Color Filter	<b>T7411</b>	Blue Green Dichroic Lens
<b>T742</b>	Warm Red Color Filter	<b>T7416</b>	Daylight Blue Correction Lens
<b>T743</b>	Daylight Blue Color Filter	<b>T7420</b>	Diffuse Spread Lens
<b>T744</b>	Med. Blue Color Filter	<b>T7422</b>	UV Filter Lens
<b>T745</b>	Med. Amber Color Filter	<b>T7477</b>	Prismatic Lens
<b>T746</b>	Med. Green Color Filter	<b>T7478</b>	Linear Spread Lens
<b>T7401</b>	Red Dichroic Lens	<b>T7459BL</b>	Hexcell Louver

## Misc. Accessories

Cat. #	Description
<b>CTA45Q-125</b>	1 1/4" Thick Ceiling Adapter
<b>CTA45Q-163</b>	1 5/8" Thick Ceiling Adapter
<b>CTA45Q-200</b>	2" Thick Ceiling Adapter
<b>HB-1</b>	(2) Real Nail 3 Bar Hangers
<b>HB-26</b>	(2) 26" C-Channel Bar Hangers
<b>HB-50</b>	(2) 50" C-Channel Bar Hangers
<b>LB-27</b>	(2) 27" Linear Bar Hangers
<b>EMI-20</b>	20W Emergency Lighting Inverter

To order, specify catalog number.



# BLACK BODY DIMMING & TUNABLE WHITE 700/1000 LUMEN ADJUSTABLE LED

3-1/4" SQUARE LENSED ANGLE CUT

**IC(9)43TSQ-431SQ, IC49TSQ-431SQ,  
TC(9)49TSQ-431SQ**

**PHOTOMETRIC REPORT**

Test Report: PT10132816R  
Catalog No: IC49TSQ-W-F-U (Aim at 30°)  
with 431SQHZ-SF trim

Watts: 19.8  
Lumens: 808  
Luminaire LPW: 41

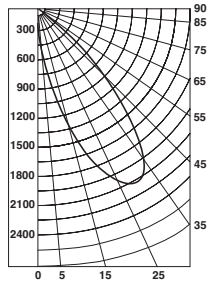

**Candlepower Distribution (Candelas)**

Degrees	Vertical Candela
0°	289
5°	529
10°	924
15°	1380
20°	1802
25°	2084
30°	2150
35°	1974
40°	1514
45°	977
50°	310
55°	84
60°	10
65°	0
70°	0
75°	0
80°	0
85°	0
90°	0

**PHOTOMETRIC REPORT**

Test Report: PT10132813R  
Catalog No: IC49TSQ-W-N-U (Aim at 30°)  
with 431SQHZ-SF trim

Watts: 19.8  
Lumens: 872  
Luminaire LPW: 44

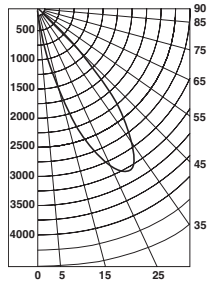

**Candlepower Distribution (Candelas)**

Degrees	Vertical Candela
0°	195
5°	413
10°	815
15°	1610
20°	2596
25°	3215
30°	3357
35°	2970
40°	2040
45°	913
50°	144
55°	31
60°	7
65°	0
70°	0
75°	0
80°	0
85°	0
90°	0

**PHOTOMETRIC REPORT**

Test Report: PT10132818R  
Catalog No: IC49TSQ-W-V-U (Aim at 30°)  
with 431SQHZ-SF trim

Watts: 19.8  
Lumens: 640  
Luminaire LPW: 32

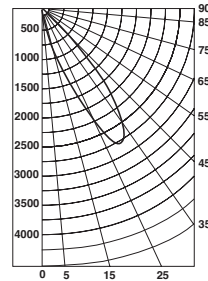

**Candlepower Distribution (Candelas)**

Degrees	Vertical Candela
0°	179
5°	225
10°	390
15°	792
20°	1447
25°	2266
30°	2774
35°	2587
40°	1676
45°	1071
50°	225
55°	50
60°	15
65°	2
70°	0
75°	0
80°	0
85°	0
90°	0

**CBCP** • Centerbeam candlepower  
**FC** • Footcandles at beam center (aim point)

In vertical aiming applications, aim point (X) is determined by dividing distance from the wall (D) by the tangent of the desired aim angle (A) (0.5774 for 30°, 1.0 for 45°).

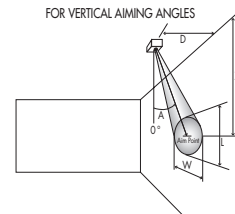
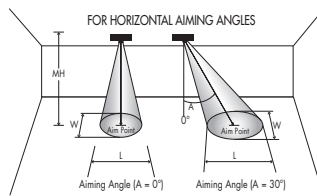

Beam Type	Beam Spread	CBCP	0°				30°			30°					40°			
			MH	FC	L	W	FC	L	W	D	FC	X	L	W	FC	X	L	W
VNFL	21°	2774	4	173	1.5	1.5	113	2.1	1.8	2	87	3.5	3.5	1.5	184	2.4	2.0	1.2
			6	77	2.3	2.3	50	3.1	2.7	3	39	5.2	5.2	2.3	82	3.6	3.0	1.8
			8	43	3.1	3.1	28	4.2	3.6	4	22	6.9	6.9	3.1	46	4.8	3.9	2.4
			10	28	3.9	3.9	18	5.2	4.4	5	14	8.7	8.7	3.9	29	6.0	4.9	3.0
			12	19	4.6	4.6	13	6.2	5.3	6	10	10.4	10.4	4.6	20	7.2	5.9	3.6
NFL	27°	3357	4	210	1.9	1.9	136	2.5	2.2	2	105	3.5	4.5	1.9	223	2.4	2.5	1.5
			6	93	2.8	2.8	61	3.8	3.2	3	47	5.2	6.7	2.8	99	3.6	3.7	2.2
			8	52	3.7	3.7	34	5.1	4.3	4	26	6.9	8.9	3.7	56	4.8	4.9	2.9
			10	34	4.7	4.7	22	6.3	5.4	5	17	8.7	11.2	4.7	36	6.0	6.1	3.6
			12	23	5.6	5.6	15	7.6	6.5	6	12	10.4	13.4	5.6	25	7.2	7.4	4.4
FL	36°	2150	4	134	2.3	2.3	87	3.2	2.7	2	67	3.5	6.2	2.3	143	2.4	3.2	1.8
			6	60	3.5	3.5	39	4.8	4.0	3	30	5.2	9.2	3.5	63	3.6	4.8	2.7
			8	34	4.6	4.6	22	6.3	5.3	4	17	6.9	12.3	4.6	36	4.8	6.3	3.6
			10	23	5.8	5.8	14	7.9	6.7	5	11	8.7	15.4	5.8	23	6.0	7.9	4.5
			12	15	6.9	6.9	10	9.5	8.0	6	7	10.4	18.5	6.9	16	7.2	9.5	5.4

Fc/Lumen Multipliers: IC(9)43TSQ - 0.70 Photometry is at 3000K CCT  
 IC49TSQ - 1.00  
 TC(9)49TSQ - 1.00

