



BLACK BODY DIMMING & TUNABLE WHITE 700/1000 LUMEN ADJUSTABLE LED

1-1/4" PINHOLE APERTURE

**IC(9)43T-433N, IC49T-433N,
TC(9)49T-433N**

PRODUCT DESCRIPTION

Recessed adjustable LED luminaire features both Black Body Dimming and Tunable White technology in a single fixture. In Black Body Dimming mode, the luminaire duplicates halogen dimming, creating a natural warm glow as the CCT shifts from 3000K to less than 1800K when dimmed. In Tunable White mode, the CCT can be adjusted anywhere along the Planckian locus from 2000K through 4350K independent of dimming. Aculux Black Body Dimming and Tunable White luminaires feature a sealed Air-Loc® housing and is available in both IC and Non-IC rated configurations.

PRODUCT SPECIFICATIONS

LED Light Engine With single dimmer connected, the light engine duplicates halogen, with the CCT shifting from 3000K at 100% to 1800K when dimmed to 1% • Connect a second dimmer to engage Tunable White mode, featuring independent dimming and CCT tuning from 2000K through 4350K • Superb color consistency within 2 SDCM of the Planckian locus over CCT range • Accurate color rendition with 90 CRI at 3000K, and 85 CRI/70 R9 throughout CCT range.

Dimming and CCT Control Black Body Dimming and CCT Tuning are compatible with most 0-10V protocol dimmers • IC rated housings are rated for 120-277V input • For Non-IC housings, specify 120V or 277V. Refer to installation instructions for detailed wiring schematics.

Modular Optics Field interchangeable optics available with 21° Very Narrow Flood, 27° Narrow Flood, or 36° Flood distributions • 50° distribution is available when AF3-50DEG accessory lens is used with 27° Narrow Flood optic • Patent pending auto-adjusting optic holder maximizes luminaire efficiency by maintaining optimal LED optic position relative to trim • Accommodates up to three (3) beam control lenses and/or filters.

Adjustability Acu-Aim™ precision geared hot-aiming achieves 370° rotation, 45° tilt • Optimized center beam optics translates light engine forward as it is aimed off nadir

Reflector .040" aluminum angle-cut reflector in black Alzak finish shields housing interior.

Trims Style Trim Ring and Flush Mount reflectors available • Trim ring features beveled knife edge for clean ceiling interface • Trim has solite lens on aperture • For flush mount installations in drywall ceilings use the FMA4 flush mount adapter • For flush mount installations in wood, stone, or tile ceilings the FMA4-SC*** must be used (specify ceiling thickness and adapter finish).

Life Rated for 50,000 hrs at 70% lumen maintenance.

Warranty 5 years from date of purchase on LED components • Standard Juno Lighting Group product guarantee terms and conditions apply.

Codes/Labels UL and cUL listed for through branch wiring, damp locations • Meets energy code Air Leakage requirements per ASTM E283 • Union made.

Mounting Available with either Patented (US Patent 8,038,113) Pro-VI™ bar hanger system, permitting quick placement of housing with 24" on-center joists or suspended ceilings, or with vertically adjustable mounting brackets (butterfly brackets). Specify mounting style when ordering.

Junction Box IC housings are rated for 4 No. 12 AWG 90°C through branch circuit conductors. • Non-IC housings are rated for 8 No. 12 AWG 90°C through branch circuit conductors. • Includes (5) 1/2", (1) 3/4", and (4) Non-metallic sheathed cable knock-outs. • Push-in electrical connectors for field connections.

Housing/Mounting Frame Housing painted black for visually dark interior • V-Notch in plaster frame and Patented (US Patent 8,277,090) Tru-Line™ Platform featuring +/- 1/2" translation aids fixture alignment after installation, prior to drywall.

Ceiling Thickness 1/2" - 7/8" ceiling standard • For thicker ceilings, order CTA4N-125 (7/8"-1 1/4"), CTA4N-163 (1 1/4"-1 5/8") or CTA4N-200 (1 5/8"- 2") • CTA4N not required for wood, stone, or tile flush mount applications.

ELECTRICAL DATA

Housing	IC(9)43T		IC49T		TC(9)49T	
Voltage	120	277	120	277	120	277
Input Power (W)	13.0	14.3	20.5	21.6	22.5	23.6
Input Current (A)	0.11	0.06	0.17	0.09	0.18	0.09
Frequency	50/60Hz		50/60Hz		50/60Hz	
Power Factor	0.99	0.92	0.99	0.92	0.99	0.92

REV-11/14

Type	Cat. No.
_____	_____
Project: _____	
Notes: _____	

DIMENSIONS

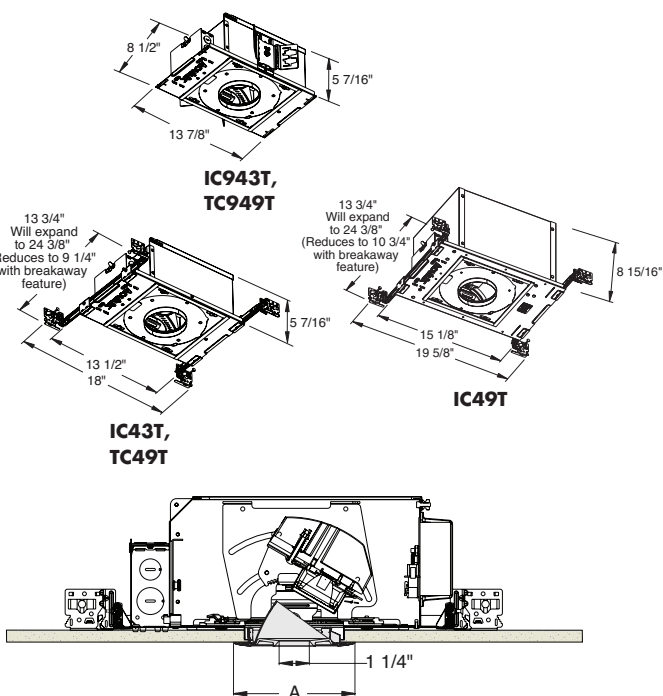

4 1/4" CEILING CUTOUT
(REFER TO INSTRUCTION SHEET FOR
FLUSH MOUNT CEILING CUTOUT)

	A
Trim Ring	5"
Flush Mount	3 7/8"

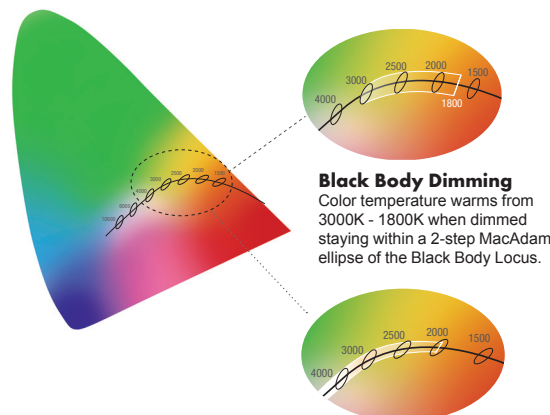

Black Body Dimming
Color temperature warms from 3000K - 1800K when dimmed staying within a 2-step MacAdam ellipse of the Black Body Locus.

Tunable White
Color temperature can be tuned from 4350K - 2000K while staying within a 2-step MacAdam ellipse of the Black Body Locus.



BLACK BODY DIMMING & TUNABLE WHITE 700/1000 LUMEN ADJUSTABLE LED

1-1/4" PINHOLE APERTURE

**IC(9)43T-433N, IC49T-433N,
TC(9)49T-433N**

Ordering Information



Housing, trim and accessories each ordered separately

Example: **TC949T-W-N-U1**

Housing	Tunable White Range	Beam Spread	Voltage/Dimming ¹	Options
<input type="text"/>	<input type="text" value="W"/>	<input type="text"/>	<input type="text"/>	<input type="text"/>
IC43T 700 Lumen, Bar Hangers (IC)	W 4350K - 2000K	V 21° Very Narrow Flood	U 120-277V, 0-10V Dimming	CP* Chicago Plenum
IC943T 700 Lumen, Butterfly Brackets (IC)		N 27° Narrow Flood	U1 120V, 0-10V Dimming	
IC49T 1000 Lumen, Bar Hangers (IC)		F 36° Flood	U2 277V, 0-10V Dimming	
TC49T 1000 Lumen, Bar Hangers (Non-IC)				
TC949T 1000 Lumen, Butterfly Brackets (Non-IC)				

*Not available on IC49T Housing.
¹ IC is Universal voltage. Specify voltage for Non-IC products.

Example: **433N-WH**

Trim		
<input type="text"/>		
		
Trim Ring	Flush Mount ¹	Description
433N-WH	433N-WH-FM	White Trim Ring
433N-ABZ	-	Aged Bronze Trim Ring
433N-SC	-	Satin Chrome Trim Ring
433N-BL	433N-BL-FM	Black Trim Ring

¹Flush Mount trims must be used with Flush Mount Adapter, ordered separately.
Product specifications subject to change without notice.

Flush Mount Adapters

Cat. #	Description
FMA4	Drywall Ceiling Adapter
FMA4-SC087-WH	Wood, Stone, Tile, 1/2"-7/8" Thick Ceiling, Adapter, White
FMA4-SC087-BL	Wood, Stone, Tile, 1/2"-7/8" Thick Ceiling, Adapter, Black
FMA4-SC125-WH	Wood, Stone, Tile, 7/8"-1 1/4" Thick Ceiling, Adapter, White
FMA4-SC125-BL	Wood, Stone, Tile, 7/8"-1 1/4" Thick Ceiling, Adapter, Black
FMA4-SC163-WH	Wood, Stone, Tile, 1 1/4"-1 5/8" Thick Ceiling, Adapter, White
FMA4-SC163-BL	Wood, Stone, Tile, 1 1/4"-1 5/8" Thick Ceiling, Adapter, Black

Optical Accessories

Cat. #	Description	Cat. #	Description
TIR-TW-V	21° Very Narrow Flood Optic	T7403	Med. Green Dichroic Lens
TIR-TW-N	27° Narrow Flood Optic	T7404	Med. Blue Dichroic Lens
TIR-TW-F	36° Flood Optic	T7405	Yellow Dichroic Lens
AF3-50DEG	50° Optic Film (Use with 27° Optic)	T7406	Magenta Dichroic Lens
T741	Med. Pink Color Filter	T7411	Blue Green Dichroic Lens
T742	Warm Red Color Filter	T7416	Daylight Blue Correction Lens
T743	Daylight Blue Color Filter	T7420	Diffuse Spread Lens
T744	Med. Blue Color Filter	T7422	UV Filter Lens
T745	Med. Amber Color Filter	T7477	Prismatic Lens
T746	Med. Green Color Filter	T7478	Linear Spread Lens
T7401	Red Dichroic Lens	T7459BL	Hexcell Louver

Misc. Accessories

Cat. #	Description
CTA4N-125	1 1/4" Thick Ceiling Adapter
CTA4N-163	1 5/8" Thick Ceiling Adapter
CTA4N-200	2" Thick Ceiling Adapter
HB-1	(2) Real Nail 3 Bar Hangers
HB-26	(2) 26" C-Channel Bar Hangers
HB-50	(2) 50" C-Channel Bar Hangers
LB-27	(2) 27" Linear Bar Hangers
EMI-20	20W Emergency Lighting Inverter

To order, specify catalog number.



BLACK BODY DIMMING & TUNABLE WHITE 700/1000 LUMEN ADJUSTABLE LED

1-1/4" PINHOLE APERTURE

**IC(9)43T-433N, IC49T-433N,
TC(9)49T-433N**

PHOTOMETRIC REPORT

Test Report #: PT10131803R
Catalog No: IC49T-W-F-U (Aim at 0°)
with 433N-WH trim

Watts: 19.8
Lumens: 311
Luminaire LPW: 16

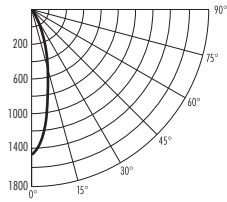

CANDLEPOWER DISTRIBUTION (Candelas)

Degrees	Vertical	0°
0	25	1451
5	35	1341
15	45	567
25	55	55
35	65	2
45	75	0
55	85	0
65	90	0
75		0
85		0
90		0

PHOTOMETRIC REPORT

Test Report #: PT10131710R
Catalog No: IC49T-W-N-U (Aim at 0°)
with 433N-WH trim

Watts: 19.8
Lumens: 356
Luminaire LPW: 18

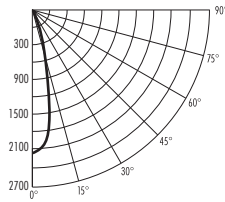

CANDLEPOWER DISTRIBUTION (Candelas)

Degrees	Vertical	0°
0	25	2167
5	35	2148
15	45	514
25	55	21
35	65	1
45	75	0
55	85	0
65	90	0
75		0
85		0
90		0

PHOTOMETRIC REPORT

Test Report #: PT10131703R
Catalog No: IC49T-W-V-U (Aim at 0°)
with 433N-WH trim

Watts: 19.8
Lumens: 171
Luminaire LPW: 9

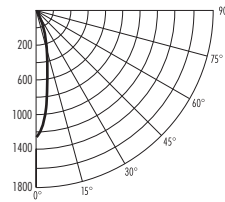

CANDLEPOWER DISTRIBUTION (Candelas)

Degrees	Vertical	0°
0	25	1319
5	35	1127
15	45	223
25	55	21
35	65	2
45	75	0
55	85	0
65	90	0
75		0
85		0
90		0

CBCP • Centerbeam candlepower
FC • Footcandles at beam center (aim point)

In vertical aiming applications, aim point (X) is determined by dividing distance from the wall (D) by the tangent of the desired aim angle (A) (0.5774 for 30°, 1.0 for 45°).

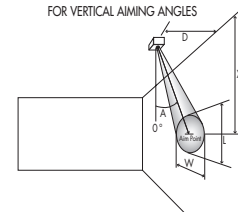
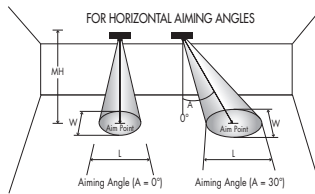

Beam Type	Beam Spread	CBCP	0°			30°			30°			40°		
			MH	FC	L W	FC	L W	D	FC	X L W	FC	X L W		
VNFL	21°	3559	4	82	1.4 1.4	54	1.9 1.6	2	41	3.5 3.0 1.4	88	2.4 1.7 1.1		
			6	37	2.1 2.1	24	2.8 2.4	3	18	5.2 4.5 2.1	39	3.6 2.6 1.6		
			8	21	2.7 2.7	13	3.7 3.2	4	10	6.9 6.0 2.7	22	4.8 3.5 2.1		
			10	13	3.4 3.4	9	4.6 4.0	5	7	8.7 7.5 3.4	14	6.0 4.3 2.7		
			12	9	4.1 4.1	6	5.6 4.8	6	5	10.4 9.0 4.1	10	7.2 5.2 3.2		
NFL	27°	3722	4	135	1.7 1.7	88	2.3 2.0	2	68	3.5 4.0 1.7	144	2.4 2.2 1.3		
			6	60	2.6 2.6	39	3.5 3.0	3	30	5.2 5.9 2.6	64	3.6 3.3 2.0		
			8	34	3.4 3.4	22	4.6 3.9	4	17	6.9 7.9 3.4	36	4.8 4.4 2.7		
			10	22	4.3 4.3	14	5.8 4.9	5	11	8.7 9.9 4.3	23	6.0 5.5 3.3		
			12	15	5.1 5.1	10	6.9 5.9	6	8	10.4 11.9 5.1	16	7.2 6.6 4.0		
FL	36°	2424	4	91	1.9 1.9	59	2.6 2.2	2	45	3.5 4.7 1.9	96	2.4 2.6 1.5		
			6	40	2.9 2.9	26	3.9 3.4	3	20	5.2 7.0 2.9	43	3.6 3.8 2.3		
			8	23	3.9 3.9	15	5.3 4.5	4	11	6.9 9.4 3.9	24	4.8 5.1 3.0		
			10	15	4.8 4.8	9	6.6 5.6	5	7	8.7 11.7 4.8	15	6.0 6.4 3.8		
			12	10	5.8 5.8	7	7.9 6.7	6	5	10.4 14.1 5.8	11	7.2 7.7 4.5		

Fc/Lumen Multipliers: IC(9)43T - 0.70 Photometry is at 3000K CCT
IC49T - 1.00
TC(9)49T - 1.00

