



# LED RECESSED ADJUSTABLE

1-3/4" LENSED REGRESSED  
PINHOLE APERTURE



Non-IC Rated, 1000 LUMEN

**TC49L-4301N, TC949L-4301N**

## PRODUCT DESCRIPTION

Recessed adjustable 20W LED luminaire with 1 3/4" lensed regressed pinhole aperture produces up to 800 fixture lumens and approximates the performance of a 75W MR16 lamp. Fixture has 50° visual cutoff and features precision geared hot-aiming. Sealed Air-Loc® housing ensures maximum energy savings and controls plenum sound transmission. Low profile Non-IC rated housing for use in non-insulated areas or where insulation is spaced at least 3" from housing.

## PRODUCT SPECIFICATIONS

**LED Light Engine** Consistent fixture to fixture color consistency within 3-step MacAdam ellipse • 2700K, 3000K, 3500K, or 4000K color temperatures are available with 85 CRI typical • 3000K also available with 93 CRI typical and R9 >80.

**Modular Optics** Available with 12° Spot, 24° Narrow Flood, or 35° Flood field interchangeable optics • 50° distribution is available when AF3-50DEG accessory lens is used with 12° Spot optic • Patent pending auto-adjusting optic holder maximizes luminaire efficiency by maintaining optimal LED optic position • Accommodates up to three (3) additional beam control lenses and/or filters.

**Adjustability** Acu-Aim™ precision geared hot-aiming achieves 370° rotation, 45° tilt • Optimized center beam optics translates light engine forward as it is aimed off nadir, ensuring maximum light and low brightness • Black aiming mechanism preserves dark aperture.

**Reflector** .040" aluminum angle-cut reflector in black Alzak finish shields housing interior.

**Trims Style** Die Cast Trim Ring and Flush Mount trims utilize torsion spring retention for tight, secure fit to ceiling • Flush mount trim creates a truly trimless aperture • Features solite glass lens on aperture • For flush mount installations in drywall ceilings use the FMA4 flush mount adapter • For flush mount installations in wood, stone, or tile ceilings the FMA4-SC\*\*\* must be used (specify ceiling thickness and adapter finish).

**LED Driver** Choice of four drivers to accommodate voltages from 120-277 volts AC • Dedicated 120V (-1) driver is dimmable with most incandescent, magnetic low voltage, and electronic low voltage dimmers • Universal Voltage (-U) driver is dimmable with most 0-10V protocol dimmers • Lutron Hi-Lume® A Series 3-wire (-L) driver is dimmable with 3-wire fluorescent controls and compatible with EcoSystem® • Lutron Hi-Lume® A Series 2-wire (-D) driver is dimmable with 2-wire forward phase dimmers containing a neutral wire • For a list of compatible dimmers, refer to [ACLXLED-DIM](#) • Power Factor > 0.9 • Field replaceable from below or above ceiling.

**Life** Rated for 50,000 hrs at 70% lumen maintenance.

**Warranty** 5 years from date of purchase on LED components • Standard Juno Lighting Group product guarantee terms and conditions apply.

**Codes/Labels** UL and cUL listed for through branch wiring, wet locations • Meets energy code Air Leakage requirements per ASTM E283 • Union made.

**Mounting** TC49L features Patented (US Patent 8,038,113) Pro-VI™ Bar Hanger System with locking set screws, permitting quick placement of housing within 24" O.C. joists or suspended ceilings • Robust bar eliminates flexing regardless of fixture position • Integral T-bar notch with locking tabs secures housing to suspended ceiling grid • Captive bugle-headed ring shank nail for quick one-step installation • Bar Hanger foot aligns to bottom of construction joist and breaks away for use in suspended ceilings.

TC949L is equipped with vertically adjustable mounting brackets that accept 1/2" conduit, "C" channels (HB-26 or HB-50), linear flat bar bars (LB-27) or 26" telescoping Real Nail bar hangers (HB-1).

**Junction Box** Rated for 8 No. 12 AWG 90° C through branch circuit conductors and includes (6) 1/2", (1) 3/4", and (4) Non-metallic sheathed cable knock-outs • Push-in electrical connectors for field connections.

**Housing/Mounting Frame** Black steel plaster frame and housing painted for visually dark interior • V-Notch in plaster frame and Patented (US Patent 8,277,090) Tru-Line™ Platform featuring +/- 1/2" translation aids fixture alignment after installation, prior to drywall.

**Ceiling Thickness** 1/2" - 7/8" ceiling standard • For thicker ceilings, order CTA4N-125 (7/8"-1 1/4"), CTA4N-163 (1 1/4"-1 5/8") or CTA4N-200 (1 5/8" - 2").

Project: \_\_\_\_\_

Fixture Type: \_\_\_\_\_

Location: \_\_\_\_\_

Contact/Phone: \_\_\_\_\_

**TC49L**



**TC949L**

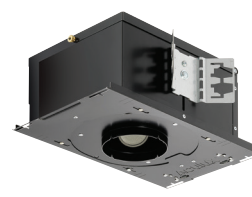

## DIMENSIONS

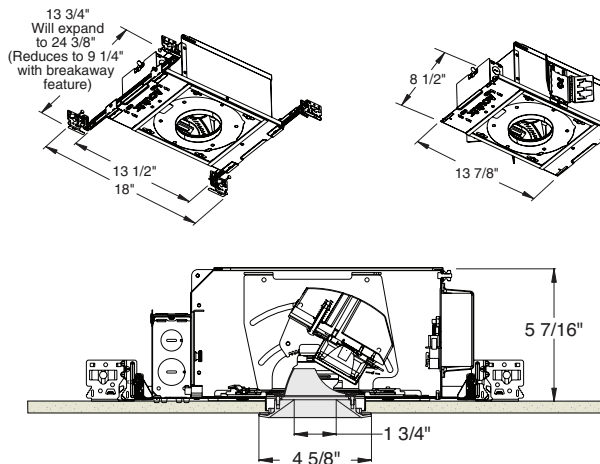

4 1/4" CEILING CUTOUT  
(REFER TO INSTRUCTION SHEET FOR  
FLUSH MOUNT CEILING CUTOUT)

|             | A      |
|-------------|--------|
| Trim Ring   | 4 5/8" |
| Flush Mount | 3 7/8" |

## ELECTRICAL DATA

| Driver Option | Dedicated 120V (-1) | Universal Voltage (-U) |      | Lutron 3-wire (-L) |      | Lutron 2-wire (-D) |
|---------------|---------------------|------------------------|------|--------------------|------|--------------------|
| Voltage       | 120                 | 120                    | 277  | 120                | 277  | 120                |
| Input Power   | 18.7                | 20.6                   | 22.1 | 19.7               | 21.1 | 20.0               |
| Input Current | 0.16                | 0.17                   | 0.08 | 0.16               | 0.08 | 0.17               |
| Frequency     | 50/60Hz             | 50/60Hz                |      | 50/60Hz            |      | 50/60Hz            |
| Power Factor  | 0.98                | 0.99                   | 0.90 | 0.99               | 0.94 | 0.98               |



# LED RECESSED ADJUSTABLE

1-3/4" LENSED REGRESSED PINHOLE APERTURE

Non-IC Rated, 1000 LUMEN

## TC49L-4301N, TC949L-4301N

### Ordering Information

Housing, trim and accessories each ordered separately

Example: **TC49L-830-N-U**

| Housings      | CRI/Color Temperature   | Beam Optics               | Drivers  | Options                  |
|---------------|-------------------------|---------------------------|--|--------------------------|
| <b>TC49L</b>  | <b>827</b> 2700K, 85CRI | <b>S</b> 12° Spot         | <b>1</b> 120V, Forward & Reverse Phase Dimming                         | <b>CP</b> Chicago Plenum |
| <b>TC949L</b> | <b>830</b> 3000K, 85CRI | <b>N</b> 24° Narrow Flood |  |                          |
|               | <b>835</b> 3500K, 85CRI | <b>F</b> 35° Flood        | <b>U</b> 120-277V, 0-10V Dimming                                       |                          |
|               | <b>840</b> 4000K, 85CRI |                           | <b>L</b> 120-277V, Lutron Hi-Lume 3-wire Dimming, Ecosystem Compatible |                          |
|               | <b>930</b> 3000K, 93CRI |                           | <b>D</b> 120V, Lutron Hi-Lume 2-wire Dimming                           |                          |

Example: **4301N-WH**

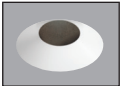
| Trim/Description  |  |                    |
|---|--|--------------------|
|          |  |                    |
| <b>Trim Ring</b>  | <b>Flush Mount<sup>1</sup></b>   | <b>Description</b> |
| <b>4301N-WH</b>   | <b>4301N-WH-FM</b>   | White Trim         |
| <b>4301N-BL</b>   | <b>4301N-BL-FM</b>   | Black Trim         |
| <sup>1</sup> Flush Mount trims must be used with Flush Mount Adapter, ordered separately. |  |                    |
| Product specifications subject to change without notice.                                  |  |                    |

### Flush Mount Adapters

| Cat. #               | Description  |
|----------------------|--|
| <b>FMA4</b>          | Drywall Ceiling Adapter  |
| <b>FMA4-SC087-WH</b> | Wood, Stone, Tile, 1/2"-7/8" Thick Ceiling, Adapter, White     |
| <b>FMA4-SC087-BL</b> | Wood, Stone, Tile, 1/2"-7/8" Thick Ceiling, Adapter, Black     |
| <b>FMA4-SC125-WH</b> | Wood, Stone, Tile, 7/8"-1 1/4" Thick Ceiling, Adapter, White   |
| <b>FMA4-SC125-BL</b> | Wood, Stone, Tile, 7/8"-1 1/4" Thick Ceiling, Adapter, Black   |
| <b>FMA4-SC163-WH</b> | Wood, Stone, Tile, 1 1/4"-1 5/8" Thick Ceiling, Adapter, White |
| <b>FMA4-SC163-BL</b> | Wood, Stone, Tile, 1 1/4"-1 5/8" Thick Ceiling, Adapter, Black |

### Optical Accessories

| Cat. #           | Description                            | Cat. #         | Description                   |
|------------------|--|----------------|-------------------------------|
| <b>TIR-1-SP</b>  | 12° Spot Optic                         | <b>T7403</b>   | Med. Green Dichroic Lens      |
| <b>TIR-1-NFL</b> | 24° Narrow Flood Optic                 | <b>T7404</b>   | Med. Blue Dichroic Lens       |
| <b>TIR-1-FL</b>  | 35° Flood Optic                        | <b>T7405</b>   | Yellow Dichroic Lens          |
| <b>AF3-50DEG</b> | 50° Optic Film<br>(Use with 12° Optic) | <b>T7406</b>   | Magenta Dichroic Lens         |
| <b>T741</b>      | Med. Pink Color Filter                 | <b>T7411</b>   | Blue Green Dichroic Lens      |
| <b>T742</b>      | Warm Red Color Filter                  | <b>T7416</b>   | Daylight Blue Correction Lens |
| <b>T743</b>      | Daylight Blue Color Filter             | <b>T7420</b>   | Diffuse Spread Lens           |
| <b>T744</b>      | Med. Blue Color Filter                 | <b>T7422</b>   | UV Filter Lens                |
| <b>T745</b>      | Med. Amber Color Filter                | <b>T7477</b>   | Prismatic Lens                |
| <b>T746</b>      | Med. Green Color Filter                | <b>T7478</b>   | Linear Spread Lens            |
| <b>T7401</b>     | Red Dichroic Lens                      | <b>T7459BL</b> | Hexcell Louver                |

### Misc. Accessories

| Cat. #           | Description                     |
|------------------|---------------------------------|
| <b>CTA4N-125</b> | 1 1/4" Thick Ceiling Adapter    |
| <b>CTA4N-163</b> | 1 5/8" Thick Ceiling Adapter    |
| <b>CTA4N-200</b> | 2" Thick Ceiling Adapter        |
| <b>HB-1</b>      | (2) Real Nail 3 Bar Hangers     |
| <b>HB-26</b>     | (2) 26" C-Channel Bar Hangers   |
| <b>HB-50</b>     | (2) 50" C-Channel Bar Hangers   |
| <b>LB-27</b>     | (2) 27" Linear Bar Hangers      |
| <b>EMI-20</b>    | 20W Emergency Lighting Inverter |

To order, specify catalog number.



# LED RECESSED ADJUSTABLE

## 1-3/4" LENSED REGRESSED PINHOLE APERTURE

Non-IC Rated, 1000 LUMEN

### TC49L-4301N, TC949L-4301N

**PHOTOMETRIC REPORT**

Test Report: PT05121602  
 Catalog No: TC49L-830-S-U (Aim at 0°)  
 with 4301N-WH trim  
**Luminaire Spacing Criterion:** 0.3  
**Watts:** 20.0  
**Lumens:** 771  
**Luminaire LPW:** 38.6

**Candlepower Distribution**  
 (Candelas)

| Degrees Vertical | 0°   |
|------------------|------|
| 0°               | 7098 |
| 5°               | 5037 |
| 10°              | 2429 |
| 15°              | 898  |
| 20°              | 289  |
| 25°              | 90   |
| 30°              | 30   |
| 35°              | 10   |
| 40°              | 4    |
| 45°              | 0    |
| 50°              | 0    |
| 55°              | 0    |
| 60°              | 0    |
| 65°              | 0    |
| 70°              | 0    |
| 75°              | 0    |
| 80°              | 0    |
| 85°              | 0    |
| 90°              | 0    |

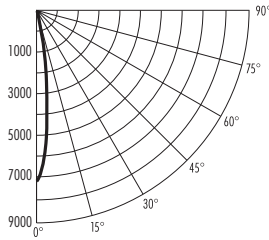

**PHOTOMETRIC REPORT**

Test Report: PT07102001  
 Catalog No: TC49L-830-N-U (Aim at 0°)  
 with 4301N-WH trim  
**Luminaire Spacing Criterion:** 0.41  
**Watts:** 20.0  
**Lumens:** 780  
**Luminaire LPW:** 39.0

**Candlepower Distribution**  
 (Candelas)

| Degrees Vertical | 0°   |
|------------------|------|
| 0°               | 3779 |
| 5°               | 3309 |
| 10°              | 2362 |
| 15°              | 1269 |
| 20°              | 509  |
| 25°              | 189  |
| 30°              | 72   |
| 35°              | 27   |
| 40°              | 10   |
| 45°              | 4    |
| 50°              | 0    |
| 55°              | 0    |
| 60°              | 0    |
| 65°              | 0    |
| 70°              | 0    |
| 75°              | 0    |
| 80°              | 0    |
| 85°              | 0    |
| 90°              | 0    |

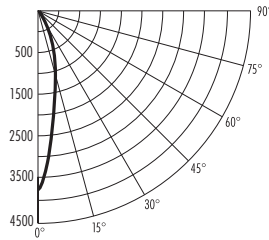

**CBCP** • Centerbeam candlepower  
**FC** • Footcandles at beam center (aim point)

In vertical aiming applications, aim point (X) is determined by dividing distance from the wall (D) by the tangent of the desired aim angle (A) (0.5774 for 30°, 1.0 for 45°).

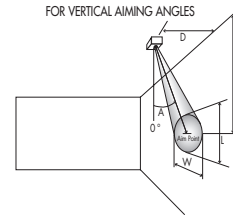
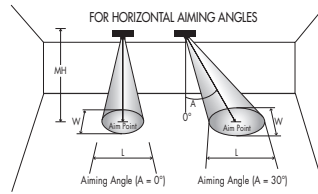

| LED           | Beam Type | Beam Spread° | Rated Life | CBCP  | 0° |         |         | 30°      |         |    | 30°           |               |              | 40°         |   |     |
|---------------|-----------|--------------|------------|-------|----|---------|---------|----------|---------|----|---------------|---------------|--------------|-------------|---|-----|
|               |           |              |            |       | MH | FC      | L W     | FC       | L W     | D  | FC            | X             | L W          | FC          | X | L W |
| 3000K, 85 CRI | SP        | 12°          | 50,000     | 12950 | 6  | 360     | 1.3 1.3 | 234      | 1.7 1.5 | 3  | 180           | 5.2 2.6 1.3   | 382          | 3.6 1.6 1.0 |   |     |
|               |           |              |            |       | 8  | 202     | 1.7 1.7 | 131      | 2.3 1.9 | 4  | 101           | 6.9 3.5 1.7   | 215          | 4.8 2.1 1.3 |   |     |
|               |           |              |            |       | 10 | 130     | 2.1 2.1 | 84       | 2.8 2.4 | 5  | 65            | 8.7 4.3 2.1   | 138          | 6.0 2.6 1.6 |   |     |
|               |           |              |            |       | 12 | 90      | 2.5 2.5 | 58       | 3.4 2.9 | 6  | 45            | 10.4 5.2 2.5  | 96           | 7.2 3.1 2.0 |   |     |
|               |           |              |            |       | 14 | 66      | 2.9 2.9 | 43       | 3.9 3.4 | 7  | 33            | 12.1 6.1 2.9  | 70           | 8.3 3.6 2.3 |   |     |
|               |           |              |            |       | 6  | 367     | 1.7 1.7 | 238      | 2.3 2.0 | 2  | 183           | 3.5 3.9 1.7   | 389          | 2.4 2.2 1.3 |   |     |
|               | NFL       | 24°          | 50,000     | 5864  | 6  | 163     | 2.6 2.6 | 106      | 3.5 2.9 | 3  | 81            | 5.2 5.9 2.6   | 173          | 3.6 3.3 2.0 |   |     |
|               |           |              |            |       | 8  | 92      | 3.4 3.4 | 60       | 4.6 3.9 | 4  | 46            | 6.9 7.9 3.4   | 97           | 4.8 4.4 2.6 |   |     |
|               |           |              |            |       | 10 | 59      | 4.3 4.3 | 38       | 5.8 4.9 | 5  | 29            | 8.7 9.8 4.3   | 62           | 6.0 5.5 3.3 |   |     |
|               |           |              |            |       | 12 | 41      | 5.1 5.1 | 26       | 6.9 5.9 | 6  | 20            | 10.4 11.8 5.1 | 43           | 7.2 6.6 4.0 |   |     |
|               |           |              |            |       | 4  | 138     | 2.5 2.5 | 90       | 3.5 2.9 | 2  | 69            | 3.5 7.2 2.5   | 147          | 2.4 3.6 2.0 |   |     |
|               |           |              |            |       | 6  | 61      | 3.8 3.8 | 40       | 5.2 4.4 | 3  | 31            | 5.2 10.8 3.8  | 65           | 3.6 5.3 2.9 |   |     |
| FL            | 35°       | 50,000       | 2212       | 8     | 35 | 5.0 5.0 | 22      | 7.0 5.8  | 4       | 17 | 6.9 14.4 5.0  | 37            | 4.8 7.1 3.9  |             |   |     |
|               |           |              |            | 10    | 22 | 6.3 6.3 | 14      | 8.7 7.3  | 5       | 11 | 8.7 18.0 5.0  | 23            | 6.0 8.9 4.9  |             |   |     |
|               |           |              |            | 12    | 15 | 7.6 7.6 | 10      | 10.4 8.7 | 6       | 8  | 10.4 21.6 7.6 | 16            | 7.2 10.7 5.9 |             |   |     |

Multipliers: 827 - 0.92  
 930 - 0.92  
 835 - 1.01  
 840 - 1.02



1300 S. Wolf Road • Des Plaines, IL 60018 • Phone (847) 827-9880 • Fax (847) 827-2925  
 220 Chrysler Drive • Brampton, Ontario • Canada L6S 6B6 • Phone (905) 792-7335 • Fax (905) 792-0064  
 Visit us at [www.junolightinggroup.com](http://www.junolightinggroup.com)