



LED RECESSED ADJUSTABLE 3-1/4" ANGLE CUT APERTURE



IC Rated, 700 LUMEN

IC43L-438N, IC943L-438N

PRODUCT DESCRIPTION

Recessed adjustable 13W LED luminaire with 3 1/4" angle cut cone produces up to 700 fixture lumens and approximates the performance of a 50W MR16 lamp. Fixture has 50° visual cutoff and features precision geared hot-aiming. Sealed Air-Loc® housing ensures maximum energy savings and controls plenum sound transmission. Low profile IC rated housing for use in insulated or non-insulated areas.

PRODUCT SPECIFICATIONS

LED Light Engine Consistent fixture to fixture color consistency within 3-step MacAdam ellipse • 2700K, 3000K, 3500K, or 4000K color temperatures are available with 85 CRI typical • 3000K also available with 93 CRI typical and R9 >80.

Modular Optics Available with 12° Spot, 24° Narrow Flood, or 35° Flood field interchangeable optics • 50° distribution is available when AF3-50DEG accessory lens is used with 12° Spot optic • Patent pending auto-adjusting optic holder maximizes luminaire efficiency by maintaining optimal LED optic position • Accommodates up to three (3) additional beam control lenses and/or filters.

Adjustability Acu-Aim™ precision geared hot-aiming achieves 370° rotation, 45° tilt • Optimized center beam optics translates light engine forward as it is aimed off nadir, ensuring maximum light and low brightness • Black aiming mechanism preserves dark aperture.

Reflector .040" aluminum angle-cut reflector in clear, gold, black, haze, or wheat haze Alzak finish provides 50° cut-off.

Trims Style Trim Ring, Self Flanged and Flush Mount reflectors utilize torsion spring retention for tight, secure fit to ceiling • Trim ring features beveled knife edge for clean ceiling interface • Self Flanged reflectors with polished or optional white painted flange • For flush mount installations in drywall ceilings use the FMA4 flush mount adapter • For flush mount installations in wood, stone, or tile ceilings the FMA4-SC*** must be used (specify ceiling thickness and adapter finish).

LED Driver Choice of four drivers to accommodate voltages from 120-277 volts AC • Dedicated 120V (-1) driver is dimmable with most incandescent, magnetic low voltage, and electronic low voltage dimmers • Universal Voltage (-U) driver is dimmable with most 0-10V protocol dimmers • Lutron Hi-Lume® A Series 3-wire (-L) driver is dimmable with 3-wire fluorescent controls and compatible with EcoSystem® • Lutron Hi-Lume® A Series 2-wire (-D) driver is dimmable with 2-wire forward phase dimmers containing a neutral wire • For a list of compatible dimmers, refer to [ACLXLED-DIM](#) • Power Factor > 0.9 • Field replaceable from below or above ceiling.

Life Rated for 50,000 hrs at 70% lumen maintenance.

Warranty 5 years from date of purchase on LED components • Standard Juno Lighting Group product guarantee terms and conditions apply.

Codes/Labels UL and cUL listed for through branch wiring, damp locations • Meets energy code Air Leakage requirements per ASTM E283 • ENERGY STAR® Qualified • 90CRI is certified to high efficacy requirements of California T24 with select trims • Union made.

Mounting IC43L features Patented (US Patent 8,038,113) Pro-VI™ Bar Hanger System with locking set screws, permitting quick placement of housing within 24" O.C. joists or suspended ceilings • Robust bar eliminates flexing regardless of fixture position • Integral T-bar notch with locking tabs secures housing to suspended ceiling grid • Captive bugle-headed ring shank nail for quick one-step installation • Bar Hanger foot aligns to bottom of construction joist and breaks away for use in suspended ceilings.

IC943L is equipped with vertically adjustable mounting brackets that accept 1/2" conduit, "C" channels (HB-26 or HB-50), linear flat bars (LB-27) or 26" telescoping Real Nail bar hangers (HB-1).

Junction Box Rated for 4 No. 12 AWG 90° C through branch circuit conductors and includes (6) 1/2", (1) 3/4", and (4) Non-metallic sheathed cable knock-outs • Push-in electrical connectors for field connections.

Housing/Mounting Frame Black steel plaster frame and housing painted for visually dark interior • V-Notch in plaster frame and Patented (US Patent 8,277,090) Tru-Line™ Platform featuring +/- 1/2" translation aids fixture alignment after installation, prior to drywall.

Ceiling Thickness 1/2" - 7/8" ceiling standard • For thicker ceilings, order CTA4N-125 (7/8"-1 1/4"), CTA4N-163 (1 1/4"-1 5/8") or CTA4N-200 (1 5/8"-2") • CTA4N not required for wood, stone, or tile flush mount applications.

REV-11/14

Project: _____

Fixture Type: _____

Location: _____

Contact/Phone: _____

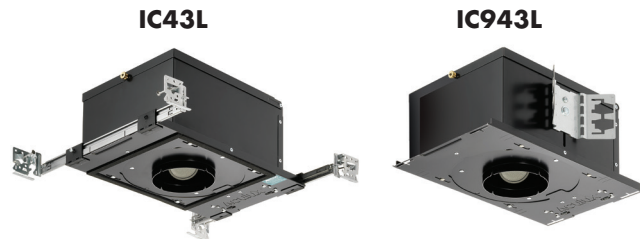

DIMENSIONS

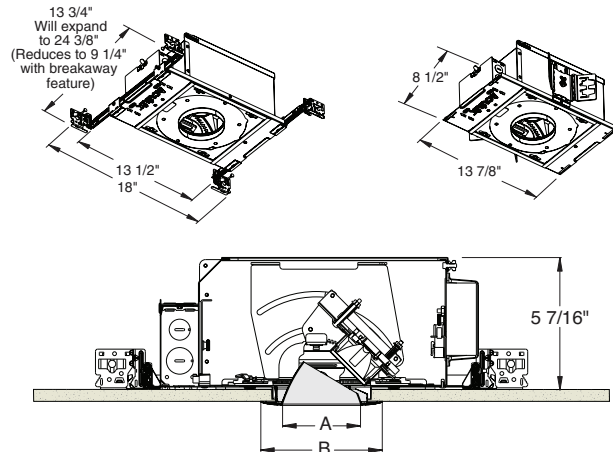

4 1/4" CEILING CUTOUT
(REFER TO INSTRUCTION SHEET FOR
FLUSH MOUNT CEILING CUTOUT)

	A	B
Trim Ring	3 1/4"	5"
Self Flanged	3 3/8"	4 5/8"
Flush Mount	3 3/8"	3 7/8"

ELECTRICAL DATA

Driver Option	Dedicated 120V (-1)	Universal Voltage (-U)		Lutron 3-wire (-L)	Lutron 2-wire (-D)
Voltage	120	120	277	120	277
Input Power	12.8	13.7	14.1	12.6	13.6
Input Current	0.10	0.11	0.05	0.10	0.05
Frequency	50/60Hz	50/60Hz		50/60Hz	50/60Hz
Power Factor	0.99	0.99	0.90	0.99	0.94



LED RECESSED ADJUSTABLE

3-1/4" ANGLE CUT APERTURE

IC Rated, 700 LUMEN

IC43L-438N, IC943L-438N

Ordering Information Housing, trim and accessories each ordered separately

Example: **IC43L-830-N-1**

Housings	CRI/Color Temperature	Beam Optics	Drivers	Options
IC43L	827 † 2700K, 85CRI	S 12° Spot	I 120V, Forward & Reverse Phase Dimming	CP Chicago Plenum
IC943L	830 † 3000K, 85CRI	N 24° Narrow Flood		
	835 † 3500K, 85CRI	F 35° Flood	U 120-277V, 0-10V Dimming	
	840 † 4000K, 85CRI		L 120-277V, Lutron Hi-Lume 3-wire Dimming, Ecosystem Compatible	
	930 3000K, 93CRI		D 120V, Lutron Hi-Lume 2-wire Dimming	

†Not T24 certified.

Example: **438NB-WH**

Trim/Description			
Trim Ring ¹	Self Flanged ²	Flush Mount ³	Description
438NB-WH*	438NB-SF*	438NB-FM*	Black Cone, White Ring
438NB-ABZ*	-	-	Black Cone
438NB-SC*	-	-	Black Cone
438NC-WH	438NC-SF	438NC-FM	Clear Cone
438NG-WH	438NG-SF	438NG-FM	Gold Cone
438NHZ-SC	-	-	Haze Cone
438NHZ-WH	438NHZ-SF	438NHZ-FM	Haze Cone, White Ring
438NWHZ-ABZ	-	-	Wheat Haze Cone
438NWHZ-WH	438NWHZ-SF	438NWHZ-FM	Wheat Haze Cone, White Ring

¹Trim Ring Finish: ABZ - Classic Aged Bronze, SC - Satin Chrome, WH - White.

²For self flanged reflector with optional white painted flange, replace "-SF" suffix with "-SFWH".

³Flush Mount trims must be used with Flush Mount Adapter, ordered separately.

*Not T24 or ENERGY STAR® Qualified.

Product specifications subject to change without notice.

Flush Mount Adapters

Cat. #	Description
FMA4	Drywall Ceiling Adapter
FMA4-SC087-WH	Wood, Stone, Tile, 1/2"-7/8" Thick Ceiling, Adapter, White
FMA4-SC087-BL	Wood, Stone, Tile, 1/2"-7/8" Thick Ceiling, Adapter, Black
FMA4-SC125-WH	Wood, Stone, Tile, 7/8"-1 1/4" Thick Ceiling, Adapter, White
FMA4-SC125-BL	Wood, Stone, Tile, 7/8"-1 1/4" Thick Ceiling, Adapter, Black
FMA4-SC163-WH	Wood, Stone, Tile, 1 1/4"-1 5/8" Thick Ceiling, Adapter, White
FMA4-SC163-BL	Wood, Stone, Tile, 1 1/4"-1 5/8" Thick Ceiling, Adapter, Black

Optical Accessories

Cat. #	Description	Cat. #	Description
TIR-1-SP	12° Spot Optic	T7403	Med. Green Dichroic Lens
TIR-1-NFL	24° Narrow Flood Optic	T7404	Med. Blue Dichroic Lens
TIR-1-FL	35° Flood Optic	T7405	Yellow Dichroic Lens
AF3-50DEG	50° Optic Film (Use with 12° Optic)	T7406	Magenta Dichroic Lens
T741	Med. Pink Color Filter	T7411	Blue Green Dichroic Lens
T742	Warm Red Color Filter	T7416	Daylight Blue Correction Lens
T743	Daylight Blue Color Filter	T7420	Diffuse Spread Lens
T744	Med. Blue Color Filter	T7422	UV Filter Lens
T745	Med. Amber Color Filter	T7477	Prismatic Lens
T746	Med. Green Color Filter	T7478	Linear Spread Lens
T7401	Red Dichroic Lens	T7459BL	Hexcell Louver

Misc. Accessories

Cat. #	Description
CTA4N-125	1 1/4" Thick Ceiling Adapter
CTA4N-163	1 5/8" Thick Ceiling Adapter
CTA4N-200	2" Thick Ceiling Adapter
HB-1	(2) Real Nail 3 Bar Hangers
HB-26	(2) 26" C-Channel Bar Hangers
HB-50	(2) 50" C-Channel Bar Hangers
LB-27	(2) 27" Linear Bar Hangers
EMI-20	20W Emergency Lighting Inverter

To order, specify catalog number.



LED RECESSED ADJUSTABLE

3-1/4" ANGLE CUT APERTURE

IC Rated, 700 LUMEN

IC43L-438N, IC943L-438N

PHOTOMETRIC REPORT

Test Report: PT05121807
 Catalog No: IC43L-830-S-1 (Aim at 30°)
 with 438NC-WH trim

Watts: 12.9
 Lumens: 716
 Luminaire LPW: 55.5

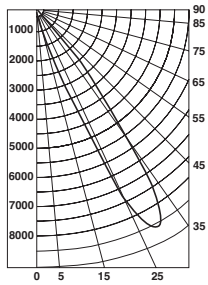

Candlepower Distribution

Degrees	Vertical Candela
0°	36
5°	64
10°	168
15°	796
20°	3240
25°	7308
30°	8536
35°	5286
40°	1603
45°	285
50°	72
55°	16
60°	2
65°	0
70°	0
75°	0
80°	0
85°	0
90°	0

PHOTOMETRIC REPORT

Test Report: PT05122101
 Catalog No: IC43L-830-N-1 (Aim at 30°)
 with 438NC-WH trim

Watts: 12.9
 Lumens: 742
 Luminaire LPW: 57.5

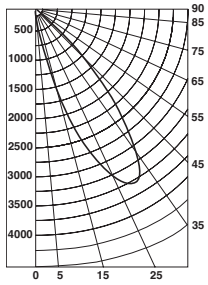

Candlepower Distribution

Degrees	Vertical Candela
0°	108
5°	185
10°	453
15°	1478
20°	2791
25°	3455
30°	3515
35°	3100
40°	2368
45°	1277
50°	328
55°	54
60°	26
65°	0
70°	0
75°	0
80°	0
85°	0
90°	0

PHOTOMETRIC REPORT

Test Report: PT05121805
 Catalog No: IC43L-830-F-1 (Aim at 30°)
 with 438NC-WH trim

Watts: 12.9
 Lumens: 734
 Luminaire LPW: 56.9

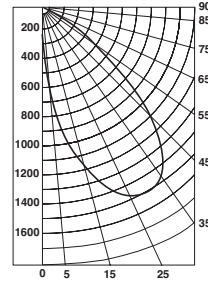

Candlepower Distribution

Degrees	Vertical Candela
0°	244
5°	575
10°	858
15°	1168
20°	1399
25°	1474
30°	1500
35°	1451
40°	1352
45°	1109
50°	774
55°	941
60°	198
65°	4
70°	0
75°	0
80°	0
85°	0
90°	0

CBCP - Centerbeam candlepower
FC - Footcandles at beam center (aim point)

In vertical aiming applications, aim point (X) is determined by dividing distance from the wall (D) by the tangent of the desired aim angle (A) (0.5774 for 30°, 1.0 for 45°).

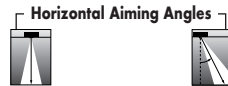
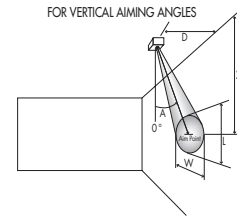
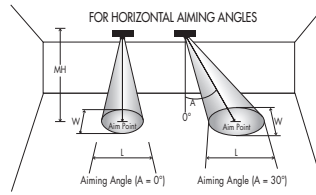

LED	Beam Type	Beam Spread°	Rated Life	CBCP	0°				30°				30°				40°			
					MH	FC	L	W	FC	L	W	D	FC	X	L	W	FC	X	L	W
3000K, 85 CRI	SP	12°	50,000	9586	6	266	1.3	1.3	173	1.7	1.5	3	133	5.2	2.6	1.3	283	3.6	1.6	1.0
					8	150	1.7	1.7	97	2.3	1.9	4	75	6.9	3.5	1.7	159	4.8	2.1	1.3
					10	96	2.1	2.1	62	2.8	2.4	5	48	8.7	4.3	2.1	102	6.0	2.6	1.6
					12	67	2.5	2.5	43	3.4	2.9	6	33	10.4	5.2	2.5	71	7.2	3.1	2.0
					14	49	2.9	2.9	32	3.9	3.4	7	24	12.1	6.1	2.9	52	8.3	3.6	2.3
	NFL	24°	50,000	4338	4	271	1.7	1.7	176	2.3	2.0	2	136	3.5	3.9	1.7	288	2.4	2.2	1.3
					6	121	2.6	2.6	78	3.5	2.9	3	60	5.2	5.9	2.6	128	3.6	3.3	2.0
					8	68	3.4	3.4	44	4.6	3.9	4	34	6.9	7.9	3.4	72	4.8	4.4	2.6
	FL	35°	50,000	1678	10	43	4.3	4.3	28	5.8	4.9	5	22	8.7	9.8	4.3	46	6.0	5.5	3.3
					12	30	5.1	5.1	20	6.9	5.9	6	15	10.4	11.8	5.1	32	7.2	6.6	4.0
					4	105	2.5	2.5	68	3.5	2.9	2	52	3.5	7.2	2.5	111	2.4	3.6	2.0
					6	47	3.8	3.8	30	5.2	4.4	3	23	5.2	10.8	3.8	50	3.6	5.3	2.9
8	26	5.0	5.0	17	7.0	5.8	4	13	6.9	14.4	5.0	28	4.8	7.1	3.9					
10	17	6.3	6.3	11	8.7	7.3	5	8	8.7	18.0	5.0	18	6.0	8.9	4.9					
12	12	7.6	7.6	8	10.4	8.7	6	6	10.4	21.6	7.6	12	7.2	10.7	5.9					

Multipliers: 827 - 0.92
 930 - 0.92
 835 - 1.01
 840 - 1.02



1300 S. Wolf Road • Des Plaines, IL 60018 • Phone (847) 827-9880 • Fax (847) 827-2925
 220 Chrysler Drive • Brampton, Ontario • Canada L6S 6B6 • Phone (905) 792-7335 • Fax (905) 792-0064
 Visit us at www.junolightinggroup.com

Printed in U.S.A. ©2014 Juno Lighting, LLC.