



# LED RECESSED ADJUSTABLE

## 1-1/4" PINHOLE APERTURE

### IC Rated, 700 LUMEN

## IC43L-433N, IC943L-433N

### PRODUCT DESCRIPTION

Recessed adjustable 13W LED luminaire with 1 1/4" pinhole aperture produces up to 450 fixture lumens and approximates the performance of a 50W MR16 lamp. Fixture has 50° visual cutoff and features precision geared hot-aiming. Sealed Air-Loc® housing ensures maximum energy savings and controls plenum sound transmission. Low profile IC rated housing for use in insulated or non-insulated areas.

### PRODUCT SPECIFICATIONS

**LLED Light Engine** Consistent fixture to fixture color consistency within 3-step MacAdam ellipse • 2700K, 3000K, 3500K, or 4000K color temperatures are available with 85 CRI typical • 3000K also available with 93 CRI typical and R9 >80.

**Modular Optics** Available with 12° Spot, 24° Narrow Flood, or 35° Flood field interchangeable optics • 50° distribution is available when AF3-50DEG accessory lens is used with 12° Spot optic • Patent pending auto-adjusting optic holder maximizes luminaire efficiency by maintaining optimal LED optic position • Accommodates up to three (3) additional beam control lenses and/or filters.

**Adjustability** Acu-Aim™ precision geared hot-aiming achieves 370° rotation, 45° tilt • Optimized center beam optics translates light engine forward as it is aimed off nadir, ensuring maximum light and low brightness • Black aiming mechanism preserves dark aperture.

**Reflector** .040" aluminum angle-cut reflector in black Alzak finish shields housing interior.

**Trims Style** Trim Ring and Flush Mount trims utilize torsion spring retention for tight, secure fit to ceiling • Trim ring features beveled knife edge for clean ceiling interface • For flush mount installations in drywall ceilings use the FMA4 flush mount adapter • For flush mount installations in wood, stone, or tile ceilings the FMA4-SC\*\*\* must be used (specify ceiling thickness and adapter finish).

**LED Driver** Choice of four drivers to accommodate voltages from 120-277 volts AC • Dedicated 120V (-1) driver is dimmable with most incandescent, magnetic low voltage, and electronic low voltage dimmers • Universal Voltage (-U) driver is dimmable with most 0-10V protocol dimmers • Lutron Hi-Lume® A Series 3-wire (-L) driver is dimmable with 3-wire fluorescent controls and compatible with EcoSystem® • Lutron Hi-Lume® A Series 2-wire (-D) driver is dimmable with 2-wire forward phase dimmers containing a neutral wire • For a list of compatible dimmers, refer to [ACLXLED-DIM](#) • Power Factor > 0.9 • Field replaceable from below or above ceiling.

**Life** Rated for 50,000 hrs at 70% lumen maintenance.

**Warranty** 5 years from date of purchase on LED components • Standard Juno Lighting Group product guarantee terms and conditions apply.

**Codes/Labels** UL and cUL listed for through branch wiring, damp locations • Meets energy code Air Leakage requirements per ASTM E283 • Union made.

**Mounting** IC43L features Patented (US Patent 8,038,113) Pro-VI™ Bar Hanger System with locking set screws, permitting quick placement of housing within 24" O.C. joists or suspended ceilings • Robust bar eliminates flexing regardless of fixture position • Integral T-bar notch with locking tabs secures housing to suspended ceiling grid • Captive bugle-headed ring shank nail for quick one-step installation • Bar Hanger foot aligns to bottom of construction joist and breaks away for use in suspended ceilings.

IC943L is equipped with vertically adjustable mounting brackets that accept 1/2" conduit, "C" channels (HB-26 or HB-50), linear flat bars (LB-27) or 26" telescoping Real Nail bar hangers (HB-1).

**Junction Box** Rated for 4 No. 12 AWG 90° C through branch circuit conductors and includes (6) 1/2", (1) 3/4", and (4) Non-metallic sheathed cable knock-outs • Push-in electrical connectors for field connections.

**Housing/Mounting Frame** Black steel plaster frame and housing painted for visually dark interior • V-Notch in plaster frame and Patented (US Patent 8,277,090) Tru-Line™ Platform featuring +/- 1/2" translation aids fixture alignment after installation, prior to drywall.

**Ceiling Thickness** 1/2" - 7/8" ceiling standard • For thicker ceilings, order CTA4N-125 (7/8"-1 1/4"), CTA4N-163 (1 1/4"-1 5/8") or CTA4N-200 (1 5/8"-2") • CTA4N not required for wood, stone, or tile flush mount applications.

Project: \_\_\_\_\_

Fixture Type: \_\_\_\_\_

Location: \_\_\_\_\_

Contact/Phone: \_\_\_\_\_

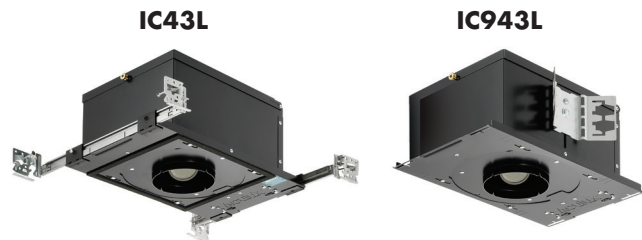

### DIMENSIONS

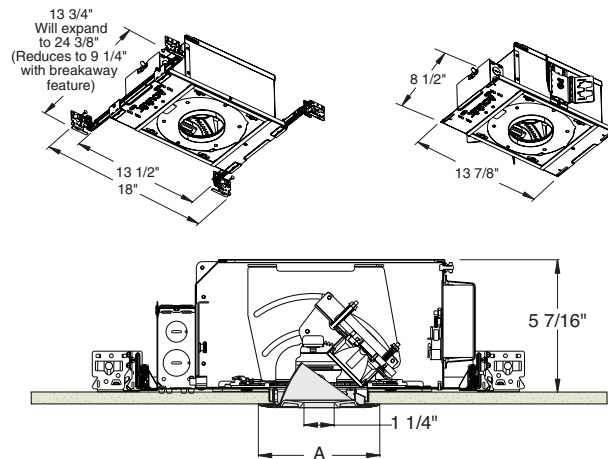

4 1/4" CEILING CUTOUT  
(REFER TO INSTRUCTION SHEET FOR  
FLUSH MOUNT CEILING CUTOUT)

	A
Trim Ring	5"
Flush Mount	3 7/8"

### ELECTRICAL DATA

Driver Option	Dedicated 120V (-1)	Universal Voltage (-U)		Lutron 3-wire (-L)		Lutron 2-wire (-D)
Voltage	120	120	277	120	277	120
Input Power	12.8	13.7	14.1	12.6	13.6	13.5
Input Current	0.10	0.11	0.05	0.10	0.05	0.11
Frequency	50/60Hz	50/60Hz		50/60Hz		50/60Hz
Power Factor	0.99	0.99	0.90	0.99	0.94	0.98

# LED RECESSED ADJUSTABLE

1-1/4" PINHOLE APERTURE

IC Rated, 700 LUMEN



**IC43L-433N, IC943L-433N**

**Ordering Information** Housing, trim and accessories each ordered separately

Example: **IC43L-830-N-1**

Housings	CRI/Color Temperature	Beam Optics	Drivers	Options
<b>IC43L</b>	<b>827</b> 2700K, 85CRI	<b>S</b> 12° Spot	<b>I</b> 120V, Forward & Reverse Phase Dimming	<b>CP</b> Chicago Plenum
<b>IC943L</b>	<b>830</b> 3000K, 85CRI	<b>N</b> 24° Narrow Flood		
	<b>835</b> 3500K, 85CRI	<b>F</b> 35° Flood	<b>U</b> 120-277V, 0-10V Dimming	
	<b>840</b> 4000K, 85CRI		<b>L</b> 120-277V, Lutron Hi-Lume 3-wire Dimming, Ecosystem Compatible	
	<b>930</b> 3000K, 93CRI		<b>D</b> 120V, Lutron Hi-Lume 2-wire Dimming	

Example: **433N-WH**

Trim/Description		
		
Trim Ring	Flush Mount <sup>1</sup>	Description
<b>433N-WH</b>	<b>433N-WH-FM</b>	White Trim Ring
<b>433N-ABZ</b>	-	Aged Bronze Trim Ring
<b>433N-SC</b>	-	Satin Chrome Trim Ring
<b>433N-BL</b>	<b>433N-BL-FM</b>	Black Trim Ring

<sup>1</sup>Flush Mount trims must be used with Flush Mount Adapter, ordered separately.  
Product specifications subject to change without notice.

**Flush Mount Adapters**

Cat. #	Description
<b>FMA4</b>	Drywall Ceiling Adapter
<b>FMA4-SC087-WH</b>	Wood, Stone, Tile, 1/2"-7/8" Thick Ceiling, Adapter, White
<b>FMA4-SC087-BL</b>	Wood, Stone, Tile, 1/2"-7/8" Thick Ceiling, Adapter, Black
<b>FMA4-SC125-WH</b>	Wood, Stone, Tile, 7/8"-1 1/4" Thick Ceiling, Adapter, White
<b>FMA4-SC125-BL</b>	Wood, Stone, Tile, 7/8"-1 1/4" Thick Ceiling, Adapter, Black
<b>FMA4-SC163-WH</b>	Wood, Stone, Tile, 1 1/4"-1 5/8" Thick Ceiling, Adapter, White
<b>FMA4-SC163-BL</b>	Wood, Stone, Tile, 1 1/4"-1 5/8" Thick Ceiling, Adapter, Black

**Optical Accessories**

Cat. #	Description	Cat. #	Description
<b>TIR-1-SP</b>	12° Spot Optic	<b>T7403</b>	Med. Green Dichroic Lens
<b>TIR-1-NFL</b>	24° Narrow Flood Optic	<b>T7404</b>	Med. Blue Dichroic Lens
<b>TIR-1-FL</b>	35° Flood Optic	<b>T7405</b>	Yellow Dichroic Lens
<b>AF3-50DEG</b>	50° Optic Film (Use with 12° Optic)	<b>T7406</b>	Magenta Dichroic Lens
<b>T741</b>	Med. Pink Color Filter	<b>T7411</b>	Blue Green Dichroic Lens
<b>T742</b>	Warm Red Color Filter	<b>T7416</b>	Daylight Blue Correction Lens
<b>T743</b>	Daylight Blue Color Filter	<b>T7420</b>	Diffuse Spread Lens
<b>T744</b>	Med. Blue Color Filter	<b>T7422</b>	UV Filter Lens
<b>T745</b>	Med. Amber Color Filter	<b>T7477</b>	Prismatic Lens
<b>T746</b>	Med. Green Color Filter	<b>T7478</b>	Linear Spread Lens
<b>T7401</b>	Red Dichroic Lens	<b>T7459BL</b>	Hexcell Louver

**Misc. Accessories**

Cat. #	Description
<b>CTA4N-125</b>	1 1/4" Thick Ceiling Adapter
<b>CTA4N-163</b>	1 5/8" Thick Ceiling Adapter
<b>CTA4N-200</b>	2" Thick Ceiling Adapter
<b>HB-1</b>	(2) Real Nail 3 Bar Hangers
<b>HB-26</b>	(2) 26" C-Channel Bar Hangers
<b>HB-50</b>	(2) 50" C-Channel Bar Hangers
<b>LB-27</b>	(2) 27" Linear Bar Hangers
<b>EMI-20</b>	20W Emergency Lighting Inverter

To order, specify catalog number.



# LED RECESSED ADJUSTABLE

## 1-1/4" PINHOLE APERTURE

IC Rated, 700 LUMEN

### IC43L-433N, IC943L-433N

**PHOTOMETRIC REPORT**

Test Report: PT05121502  
 Catalog No: IC43L-830-S-1 (Aim at 0°)  
 with 433N-WH trim  
**Luminaire Spacing Criterion: 0.28**  
**Watts: 12.9**  
**Lumens: 435**  
**Luminaire LPW: 33.7**

**Candlepower Distribution**

(Candelas)	
Degrees Vertical	0°
0°	5754
5°	4022
10°	1439
15°	169
20°	35
25°	8
30°	0
35°	0
40°	0
45°	0
50°	0
55°	0
60°	0
65°	0
70°	0
75°	0
80°	0
85°	0
90°	0

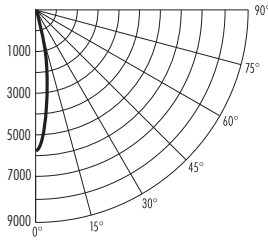

**PHOTOMETRIC REPORT**

Test Report: PT05121607  
 Catalog No: IC43L-830-N-1 (Aim at 0°)  
 with 433N-WH trim  
**Luminaire Spacing Criterion: 0.34**  
**Watts: 12.9**  
**Lumens: 465**  
**Luminaire LPW: 36.0**

**Candlepower Distribution**

(Candelas)	
Degrees Vertical	0°
0°	3472
5°	2978
10°	1819
15°	611
20°	97
25°	18
30°	0
35°	0
40°	0
45°	0
50°	0
55°	0
60°	0
65°	0
70°	0
75°	0
80°	0
85°	0
90°	0

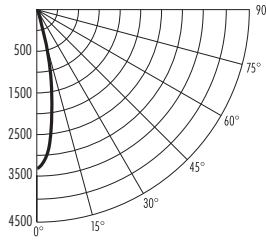

**CBCP** • Centerbeam candlepower  
**FC** • Footcandles at beam center (aim point)

In vertical aiming applications, aim point (X) is determined by dividing distance from the wall (D) by the tangent of the desired aim angle (A) (0.5774 for 30°, 1.0 for 45°).

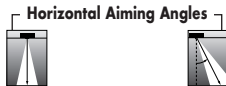
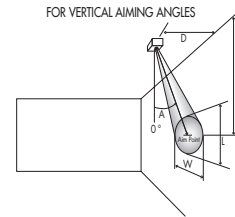
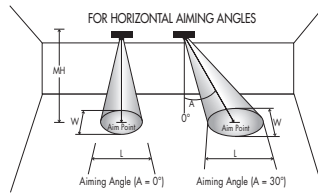

LED	Beam Type	Beam Spread°	Rated Life	CBCP	0°				30°			30°				40°				
					MH	FC	L	W	FC	L	W	D	FC	X	L	W	FC	X	L	W
3000K, 85 CRI	SP	12°	50,000	9586	6	266	1.3	1.3	173	1.7	1.5	3	133	5.2	2.6	1.3	283	3.6	1.6	1.0
					8	150	1.7	1.7	97	2.3	1.9	4	75	6.9	3.5	1.7	159	4.8	2.1	1.3
					10	96	2.1	2.1	62	2.8	2.4	5	48	8.7	4.3	2.1	102	6.0	2.6	1.6
					12	67	2.5	2.5	43	3.4	2.9	6	33	10.4	5.2	2.5	71	7.2	3.1	2.0
	NFL	24°	50,000	4338	4	271	1.7	1.7	176	2.3	2.0	2	136	3.5	3.9	1.7	288	2.4	2.2	1.3
					6	121	2.6	2.6	78	3.5	2.9	3	60	5.2	5.9	2.6	128	3.6	3.3	2.0
					8	68	3.4	3.4	44	4.6	3.9	4	34	6.9	7.9	3.4	72	4.8	4.4	2.6
					10	43	4.3	4.3	28	5.8	4.9	5	22	8.7	9.8	4.3	46	6.0	5.5	3.3
	FL	35°	50,000	1678	4	105	2.5	2.5	68	3.5	2.9	2	52	3.5	7.2	2.5	111	2.4	3.6	2.0
					6	47	3.8	3.8	30	5.2	4.4	3	23	5.2	10.8	3.8	50	3.6	5.3	2.9
					8	26	5.0	5.0	17	7.0	5.8	4	13	6.9	14.4	5.0	28	4.8	7.1	3.9
					10	17	6.3	6.3	11	8.7	7.3	5	8	8.7	18.0	5.0	18	6.0	8.9	4.9
					12	12	7.6	7.6	8	10.4	8.7	6	6	10.4	21.6	7.6	12	7.2	10.7	5.9

Multipliers: 827 - 0.92  
 930 - 0.92  
 835 - 1.01  
 840 - 1.02

