

DESCRIPTION

The LPX combo series is a UL 924 code compliant solution for exit and emergency requirements and is designed to operate for a minimum of 90 minutes during a power outage. Features include a polycarbonate housing, LED sources for both the exit letters and the emergency heads, as well as a labor saving self-diagnostic option that automatically performs required NFPA testing. The Exit is field configurable for either red or green letters. The LED emergency heads are available with 25 feet or 50 feet of egress coverage. The LED sources and nickel cadmium battery require no maintenance. Product options include exits or combos with remote capacity that can be used for extended run times or to power Sure-Lites SRP/SRM LED remotes.

SPECIFICATION FEATURES

Electrical

General Features

- Field selected red and green sign letters standard on all units (units shipped red, field convertible to green with supplied parts).
- Dual Voltage Input 120/277 VAC, 60 Hz
- 240 VAC capable with 48 hour rechargeable time
- Sure-Lites EZ Key patented external battery disconnect feature – prevents unnecessary battery drainage, saves on installation time
- Solid-state voltage limited charger
- Brownout circuit
- Low-voltage disconnect
- Test switch/power indicator light
- Standard 24 hour recharge time (max)
- Self-Diagnostic feature available as an option
- Laser test capability with Self-Diagnostic

Remote Capacity

- Remote capacity is available in the combo (3 watts) or the exit (5 watts)
- Remote capable versions are compatible with the Sure-Lites SRM and SRP series

Emergency Heads

- LED emergency heads are available with 100 lumens/head (25 feet of coverage) or 200 lumens/head (50 feet of coverage) of emergency light output.
- Heads can be mounted to top or sides of exit

Housing Construction

- All components are injection molded, color stable, high impact UL 94-5VA rated polycarbonate material
- White or black textured finish standard
- Components are of snap-fit construction to enable under 5-minute installation
- Molded-in wireways facilitate internal wire routing and connections
- Field adjustable snap-out or snap-in chevron directional indicators have full 3/4" stroke
- Knockout provided on housing for surface attachment mount install
- Universal exits can be field configured as single face or double face
- Snap-fit canopy with captive mounting screws included with all exits

Catalog #		Type
Project		
Comments		Date
Prepared by		

- Combo can be ceiling, wall, or end mounted
- Universal J-box mounting pattern

Code Compliance

- UL 924 Listed
- UL Damp Location (0° C - 40° C)
- Life Safety NFPA 101
- NEC/OSHA
- Most State and Local Codes
- California Energy Code

Warranty

- Fixture: 5-Year
- Battery: 7-year pro-rata



LPXC SERIES

POLYCARBONATE COMBO
SURFACE MOUNT
LED LAMPS
EMERGENCY EXIT LIGHTING
SELF DIAGNOSTICS
REMOTE CAPACITY
NICKEL CADMIUM BATTERY

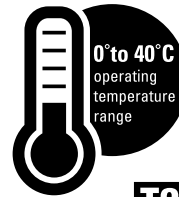

T20 Certified to California Title 20 Appliance Database

LPXC

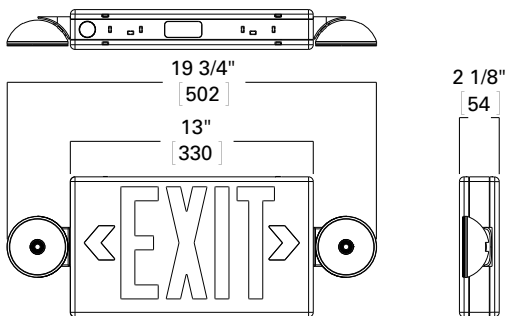

LPX

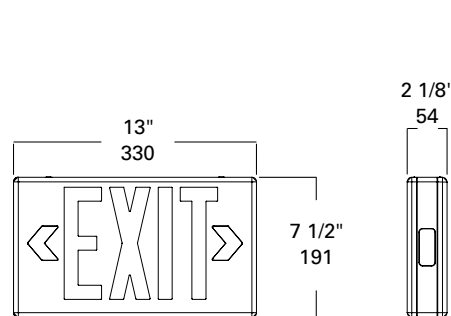

ENERGY DATA

Input Voltage	Input Power
120 VAC	2.2 watts
240 VAC	2.5 watts
277 VAC	3.2 watts
DLVP non-SD (57 Vdc)	1.8 watts
DLVP SD (57 Vdc)	3.0 watts

CATALOG LOGIC

Series	Coverage	Remote Capacity	Color	Self Diagnostics	Full Catalog Logic
LPXC = LED polycarbonate Combo	25 = 25 feet	_ = 0 watts R3 = 3 watts	_ = white	_ = no self diagnostics SD = self diagnostics	LPXC25, LPXC25R3, LPXC25SD, LPXC25R3SD
LPXC = LED polycarbonate Combo	25 = 25 feet	_ = 0 watts R3 = 3 watts	BK = black	SD = self diagnostics (standard)	LPXC25BKSD, LPXC25R3BKSD
LPXC = LED polycarbonate Combo	50 = 50 feet	not available	_ = white BK = black	SD = self diagnostics (standard)	LPXC50SD, LPXC50BKSD
LPX = LED polycarbonate Exit	not applicable	R5 = 5 watts	_ = white BK = black	SD = self diagnostics (standard)	LPXR5SD, LPXR5BKSD

DLVP OPTIONS

Series	Coverage	Remote Capacity	Color	Self Diagnostics	DLVP	Full Catalog Logic
LPXC=LED polycarbonate Combo	25 = 25 feet	_ = 0 watts	_ = white BK = black	_ = no self diagnostics	DLVP= DLVP	LPXC25BKDLVP, LPXC25DLVP
LPXC = LED polycarbonate Combo	25 = 25 feet	_ = 0 watts R3 = 3 watts	_ = white BK = black	SD = self diagnostics (standard)	DLVP= DLVP	LPXC25SDDLVP, LPXC25BKSDDLVP, LPXC25R3SDDLVP, LPXC25R3BKSDDLVP

REMOTE LOGIC

Series	SEL Series Outdoor Capable Remotes					
	Single Head Remotes			Double Head Remotes		
	SRP/SRM13	SRP/SRM25	SRP/SRM30	SRP25D/ SRM25D	SRP50D/ SRM50D	SRP60D/ SRM60D
Catalog number						
Watts Consumed	1.25	2.5	4.1	2.5	5	8.2

Catalog Number	Remote Watts Available	# of SRP/SRM13 remotes fixture will power	# of SRP/SRM25 remotes fixture will power	# of SRP/SRM30 remotes fixture will power	# of SRP25D/ SRM25D remotes fixture will power	# of SRP50D/ SRM50D remotes fixture will power	# of SRP60D/ SRM60D remotes fixture will power
LPXC25R3	3	2	1	NA	1	NA	NA
LPXR5	5	4	2	1	2	1	NA



SRP



SRPD



SRM



SRMD

PHOTOMETRY

LPXC25

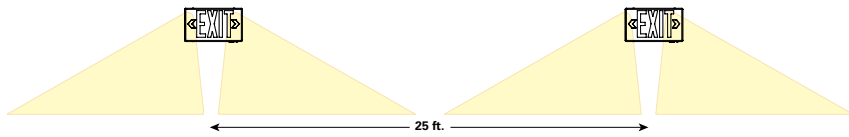
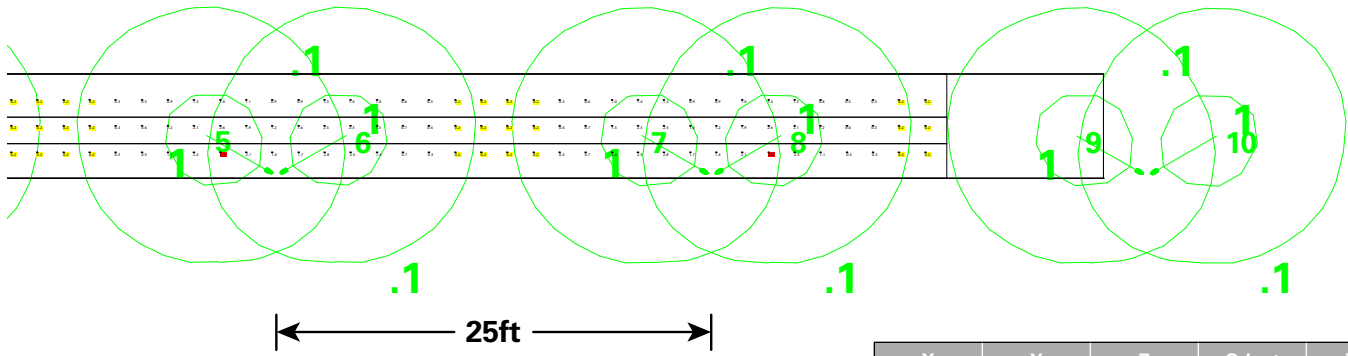

X	Y	Z	Orient	Tilt
-0.5	0.25	7.5	125	27
0.5	0.25	7.5	55	27
16.5	0.211	7.5	125	27
17.5	0.212	7.5	55	27
33.5	0.172	7.5	125	27
34.5	0.173	7.5	55	27
50.5	0.132	7.5	125	27
51.5	0.135	7.5	55	27
67.5	0.093	7.5	125	27
68.5	0.096	7.5	55	27
84.5	0.054	7.5	125	27
85.5	0.058	7.5	55	27
101.5	0.015	7.5	125	27
102.5	0.019	7.5	55	27

LPXC50

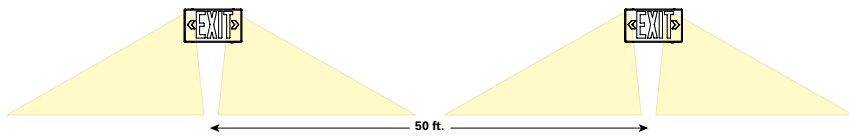
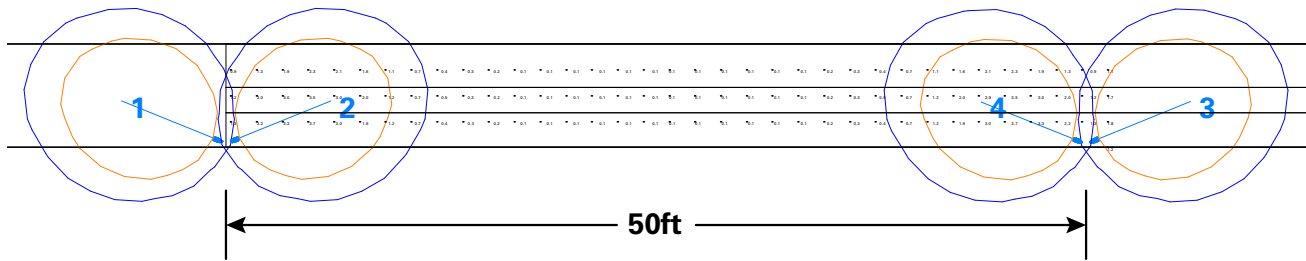

X	Y	Z	Orient	Tilt
24.25	0.33	7.5	158	40
24.75	0.33	7.5	22	40
74.75	0.3	7.5	22	40
74.25	0.292	7.5	158	40

***The "Rule of Thumb" spacing guidelines are designed to achieve 1 foot-candle average and 0.1 foot-candle minimum with a 40:1 maximum/minimum ratio. The corridor used is 100 feet long, 9 foot ceiling with a 6 foot wide walkway and 3 foot path of egress. The reflectances are 80% ceiling, 50% walls and 20% floors. The fixture mounting height is 7.5 feet. Cooper Lighting Solutions assumes no responsibility for local requirements or specific project variables. This is a guideline to be used as a design aid, not as guarantee of any code compliance.

TECHNICAL DATA

Exit Lamps

LPXC Series Exits use energy efficient, long life LED's to provide uniform diffuse illumination of the exit face. These red and green LEDs require no maintenance and consume less than one watt, on average. The LED's are powered from AC input during normal operation and from the battery during a power outage.

Emergency Heads

The LPXC series features long life LED's for the emergency source. These LED's require no maintenance and are available with 100 lumens/head or 200 lumens/head output. The heads are adjustable and can be mounted on the top or side of the exit housing.

Housing Construction

Rugged, durable, injection molded polycarbonate materials are used throughout the LPXC Series. All structural components are designed with reinforcing ribs to add additional rigidity and to maximize structural integrity. These materials are impact and scratch resistant, and they have been UV stabilized to resist discoloration due to age and ultraviolet radiation. All components are designed to be of snap-fit construction - no mechanical fasteners - to facilitate installation in under 5-minutes. Any components required for installation (wirenuts, wire leads, universal metal J-box bracket, etc.) are all included. The universal design of the LPXC Series enables exits to be configured as single face or double face in the field. All LPXC series Combo's can be wall, ceiling, or end mounted; a rugged, snap-fit, low profile canopy with captive screws is included with every exit for ceiling and end mounting application.

Lens

Lenses for the LPXC Series are made from durable, impact resistant polycarbonate. All exit faces are designed with full 3/4" stroke snap-out or snap-in chevron directional indicators to insure maximum visibility and compliance with the latest codes. Units come with red lenses installed and green lenses included for field selectable red or green signs.

Brownout Circuit

The brownout circuit on Sure-Lites' exits monitors the flow of AC current to the exit and activates the emergency lighting system when a predetermined reduction of AC power occurs. This dip in voltage can cause fixtures to extinguish resulting in a loss of normal lighting even though a total power failure has not occurred.

Solid-State Transfer

The LPXC Series incorporates solid-state switching which eliminates corroded and pitted contacts or mechanical failures associated with relays. The switching circuit is designed to detect a loss of AC voltage and automatically energizes the lamps using DC power. Upon restoration of AC power, the DC power will be disconnected and the charger will automatically recharge the battery.

Low Voltage Disconnect

When the battery's terminal voltage falls, the low-voltage circuitry disconnects the lighting load. The disconnect remains in effect until normal utility power is restored, preventing deep battery discharge.

EZ Key - External Power Disconnect

The EZ Key is an external power disconnect. The patent EZ Key technology keeps the battery disconnected during the construction cycle. This prevents battery wear and ensures the battery maintains its charge for the inspection process. Simply remove the key once the building is commissioned.

Test Switch/Power Indicator Light

A test switch located on the side of the exit permits the activation of the emergency circuit for a complete operational systems check. The Power Indicator Light provides visual assurance that the AC power is on.

Sealed Nickel Cadmium Battery

Sure-Lites sealed nickel cadmium batteries are maintenance-free with a life expectancy of 10 years. The sealed rechargeable nickel cadmium battery offers high discharge rates and stable performance over a wide range of temperatures, from 0° C to 40° C (32 F to 104 F).

Self Diagnostics Option

The self-diagnostic unit will automatically perform all tests required by UL924, and NFPA 101. The system indicates the status of the fixture at all times using the LED indicator near the test switch on the side of the unit. A 90 minute battery power (emergency mode) simulation test will occur every 12 months. A 30 second battery power simulation test will occur every 30 days.

Laser Test

The Self-Diagnostic option include a laser pointer testing capability. Activation of the photocell test button with a laser pointer will simulate loss of AC power and engage the emergency operation of the exit and emergency heads.

Warranty

All Sure-Lites' products are backed by a firm five-year warranty against defects in material and workmanship. Maintenance-free, long-life, sealed nickel cadmium batteries carry a seven-year pro-rata warranty.



EZ Key



Laser tester
Part Number = LASER
(sold separately)

SELF DIAGNOSTIC TESTING OPERATIONS

The Sure-Lites Eagle Eye Self Diagnostics is continuously monitoring your emergency fixture, and will signal any failure through the 3 color indicator LED.

Initial Operation:

When the unit is first powered up it will go into a 24 hour fast charge and the indicator LED will pulse green. Once the unit has fully charged it will perform a self calibration. After self calibration, the LED will change to steady green indicating the unit is fully charged and float charging the battery to maintain readiness.

Automatic Testing:

The unit will perform a battery capacity, lamp/LED, and charge circuit test every 30 days for 30 seconds. During this time, the indicator LED will change to a steady yellow. It will perform a full battery capacity (90 minute) test once per year. During this time, the indicator LED will change to a blinking yellow.

Manual Testing:

- 10 Second "Installation" test – Press and release the test button once during fast charge (blinking green) to initiate a 10 second quick test. The sign will switch to emergency mode for 10 seconds allowing the installer to verify proper installation of the unit, and the LED indicator will turn solid yellow.
- 30 Second Test - Press and release the test button once during float charge (steady green). The indicator LED will turn steady yellow to indicate the unit is performing a 30 second test of the batteries and lamps/LEDs.
- 90 Minute Test - Press and release the test button a second time during a 30 second test (steady yellow) to change to a 90 minute test. During this test, the LED indicator will change to blinking yellow, and the circuit will perform a full battery capacity, charge circuit, and LED test.
- Canceling Test – Press and release the test button during the 90 minute test (flashing yellow) to return the fixture to its original state (fast charge or float charge)

Laser Test:

The SEL SD products are equipped with a Laser Test function that allows the unit to be manually tested without the need to physically press the test button. Shining a laser pointer in the hole marked "LASER TEST" on the bottom of the unit has the same effect as a press and release of the test button.

Clearing Failure Codes:

- A battery failure (LED two blink red) can be cleared by replacing the battery. Disconnecting the battery and AC power, or performing a full 90 minute discharge will reset the error code, however, it will return if the battery is faulty
- Charge Circuit (LED three blink red) and lamp/LED failure (LED four blink red) will clear when the unit successfully passes a manual or automatic 30 second test.









SELF DIAGNOSTIC TESTING OPERATIONS

Indicators:

- LED Off - No power to unit, emergency mode.
- LED Steady Green - Unit is fully charged and is float charging the battery to maintain readiness.
- LED Green Pulse - Unit is in a 24 hour fast charge of the battery.
- LED Two Blink Red - Battery has failed a capacity test, or the battery is disconnected. See "Clearing Failure Codes" above.
- LED Three Blink Red - Battery charge circuit has failed. See "Clearing Failure Codes" above.
- LED Four Blink Red - Lamps have burned out, or on an EXIT/Combo, 50% or more of the LEDs have failed. See "Clearing Failure Codes" above.
- LED Steady Yellow - 30 second test or 10 second quick test (Fast Charge only).
- LED Blinking Yellow - 90 minute test.

Maintenance:

None required. Replace the batteries as needed according to ambient conditions. However, we recommend that the equipment be tested regularly in accordance with local codes.

		OFF - EMERGENCY MODE / POWER OFF		STEADY BLINK YELLOW - 90 MINUTE TEST
		STEADY BLINK GREEN - FAST CHARGE		2 BLINK RED - BATTERY FAILURE
		STEADY GREEN - FULL / FLOAT CHARGE		3 BLINK RED - CHARGE CIRCUIT FAILURE
		STEADY YELLOW - QUICK TEST		4 BLINK RED - LAMP/LED FAILURE