



# WP1FCSN70



JOB NAME: \_\_\_\_\_  
 DATE: \_\_\_\_\_  
 TYPE: \_\_\_\_\_

## DESCRIPTION

Fully shielded, Full Cutoff Wallpack for higher wattages! Full Cutoff optics with flat tempered glass lens. EZ mount knockouts for easy wiring. Lamp supplied.

## SPECIFICATIONS

### Finish:

Chip and fade resistant polyester powder coating.

### Housing:

Die cast aluminum, 1/2" NPS tapped top, both sides and back for conduit or photocontrol. Hinged refractor. Continuous one piece silicone rubber gasket.

### Reflector:

Semi-Specular anodized aluminum, removable for installation. Symmetrical light pattern maximizes distance between fixtures.

### Conduit Openings:

Top, side, back and bottom

### UL Listing:

Suitable for wet locations. HID fixtures can be wired with 90° C supply wiring if supply wires are routed 3" away from the ballast.

### Cradle:

Capacitor cradle for better heat absorption

### Mounting:

Knockouts for easy wall box mounting

### Patents:

Pat. D561,377

### Color:

Bronze

### Weight:

8.82

## DIMENSIONS

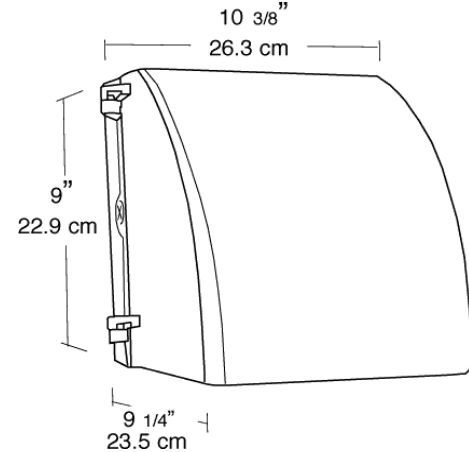

## PHOTOMETRIC

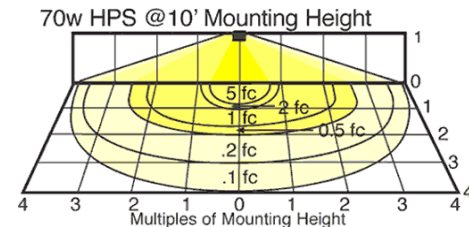

Mounting Height	Multiplier	Watts	Multiplier HPS	Multiplier MH	CFL
8'	1.6	100	1.5	1.4	
10'	1.0	70	1.0	.9	
12'	.7	50	.6	.5	
16'	.4	35	.4	.5	
20'	.25	42		.5	

## ORDERING INFORMATION

**High Pressure Sodium**  
 Lamp supplied with fixture

Total Watts	Lamp Type	Lamp Base	Ballast
70	ED17	Medium	R-NPF 120V

Starting Amps/ Operating Amps			
120V	208V	240V	277V
2.1/1.6			

Input Watts	LAMP ANSI	Initial Lumens	Lamp Hours
86	S62	6400	24000

**Factory Installed Options**  
 Add suffix to Catalog Number

Tamperproof screws (/TP)  
 Swivel Photocontrol (/PCS)  
 Single fusing for 120 and 277 volt (/F)

Button Photocontrol wired for 208 - 277 volt (/PC2)  
 Button Photocontrol (/PC)

Note: Specifications may change without notice