

HID FLOODS

FLOODZILLA!™

New Integra Hood for Friendly Lighting.
Awesome performance with quality and value
from this compact 400 & 250 watt HID flood.

New!

2" Integra Hood to reduce light trespass and glare

Better heat sinking of components

Reflector designed for precise beam control

Precision die cast aluminum housing with durable bronze or white polyester powder coat finish

PULSE START
Metal Halide

UTILITY FRIENDLY POSSIBLE

- SAVE ENERGY \$\$
- LONGER LAMP LIFE
- FASTER START TIME
- BETTER LUMEN MAINTENANCE
- LAMPS REMAIN SAME COLOR
- COLD STARTING TO -40°

Long Life Lamp supplied

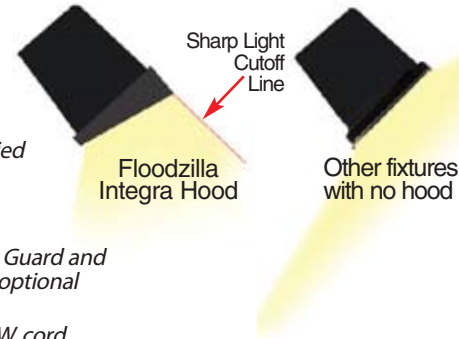

4" and 9" Hoods, Wire Guard and Polycarbonate Shield optional

Supplied with 3' of STW cord (trunion only)

Rugged Trunion or Slip Fitter Mounting



Product Information

	Watts	Lamp Type	Lamp Base	Circuit / Voltage	Starting Amps / Operating Amps				Input Watts	Lamp ANSI	Initial Lumens	Lamp Hours
					120V	208V	240V	277V				
High Pressure Sodium	250	ED18	Mogul	CWA HPF QT	1.8 / 2.5	1.0 / 1.5	0.9 / 1.3	0.8 / 1.1	295	S50	28,500	24,000
Lamp supplied with fixture	400	ED18	Mogul	CWA HPF QT	3.7 / 3.8	2.2 / 2.2	1.9 / 1.9	1.6 / 1.7	464	S51	50,000	24,000
Metal Halide	175	ED28	Mogul	CWA HPF QT	1.3 / 1.8	.8 / 1.0	.7 / .9	.6 / .8	210	M57	13,500	10,000
Lamp supplied with fixture	200	T15	Mogul	CWA HPF QT	1.4 / 2.0	.8 / 1.2	.7 / 1.0	.6 / .9	232	M136	19,000	15,000
FS* = Pulse Start	250	ED28	Mogul	CWA HPF QT	1.8 / 2.5	1.1 / 1.5	1.0 / 1.3	.8 / 1.1	295	M58	21,000	10,000
QT = Quad Tap = 120 / 208 / 240 / 277 volts	250	ED28	Mogul	CWA HPF QT	1.4 / 2.5	.8 / 1.5	.7 / 1.3	.6 / 1.1	288	M138	22,000	12,000
	320	ED28	Mogul	CWA HPF QT	2.6 / 3.2	1.5 / 1.8	1.3 / 1.6	1.2 / 1.4	368	M132	30,000	20,000
	350	ED28	Mogul	CWA HPF QT	3.3 / 3.6	1.9 / 2.1	1.7 / 1.8	1.4 / 1.6	400	M131	33,300	20,000
	400	ED28	Mogul	CWA HPF QT	2.8 / 4.0	1.6 / 2.3	1.4 / 2.0	1.3 / 1.8	458	M59	36,000	20,000
	400	ED28	Mogul	CWA HPF QT	3.5 / 4.0	2.0 / 2.3	1.8 / 2.0	1.5 / 1.8	450	M135	40,000	20,000

Factory Installed Options
 Add suffix to catalog number

Button Photocontrol
 Swivel Photocell
 480 volt only ballast (consult factory)



Specify Photocell voltage

Accessories for Field Installation

Glare hood 4" length
 Glare hood 9" length
 Polycarbonate shield
 Wire Guard

Specifications

UL Listing:
 Suitable for wet locations. Suitable for mounting within 4' of the ground.

Housing:
 Precision die cast aluminum

Reflector:
 High quality anodized aluminum

Lens:
 Tempered shock resistant glass

Lens Gasket:
 Molded one-piece silicone in die cast retaining groove to remain in place during relamping.

Socket:
 Glazed porcelain 4kv pulse rated with nickel plated screw shell and spring contacts.

Finish:
 Chip and fade resistant Bronze polyester powder coat finish.

Effective Projected Area:
 Maximum EPA = 1.3

Weight:			
Fixture	lbs	Fixture	lbs
HPS250	33	MH175	28
HPS400	35	MH200	30
		MH250	31
		MH320	31
		MH350	31
		MH400	31

Patents:
 The Floodzilla designs are protected by U.S. Patents D547478 and D547477, China Patent ZL200630133217.6 and similar patents pending under China, Taiwan, Canada and international intellectual property laws.

www.rabweb.com
 Spec sheets • EZ Lighting Layouts
 Photometrics • Wiring Diagrams
 IES Files • Installation Instructions



Photometrics

Floodlighting
 400w HPS @ 30' Mounting Height
 Aimed 45° below horizon

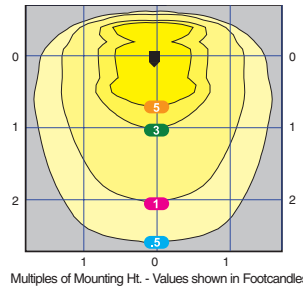

Mounting Height	Multiplier	Multiplier	
		Watts	HPS MH
15	4.0	175	-.3
20	2.3	FS*200	-.4
30	1.0	250	.6 .4
35	.7	FS*250	-.5
40	.6	FS*320	-.6
		FS*350	-.7
		400	-.7
		FS*400	1.0 .8

Sign & Wall Lighting
 400w HPS @ 10' Mounting Distance
 Aimed 45° above horizon

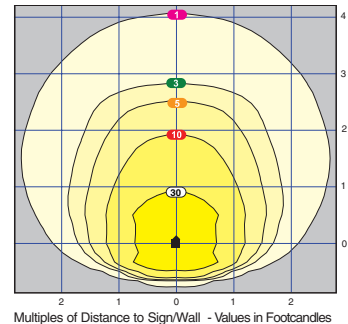

Mounting Height	Multiplier	Multiplier	
		Watts	HPS MH
5	4.0	175	-.3
10	1.0	FS*200	-.4
12	.7	250	.6 .4
15	.4	FS*250	-.5
		FS*320	-.6
		FS*350	-.7
		400	1.0 .7
		FS*400	-.8

New!

Floodzilla Trunnion

New clean design, compact, tough and good looking cast aluminum housing with 2" Integra Hood, steel trunnion mount for easy surface mounting and aiming flexibility. Factory wired for 277V, except 175W. Stainless steel screws. Lamp supplied.

Finish: ● Bronze



New!

Floodzilla Slipfitter

Floodzilla with integral slip fitter for O.D 2 3/8" tenon size. Slipfitter joint adjusts over 180° arc. Factory wired for 277V, except 175W. Lamp supplied.

Finish: ● Bronze



New!

Hood, Shield Floodzilla & Guard

Glare Hoods field install in minutes to further reduce glare and light trespass. Available in 4 1/2" or 9" lengths. Guard is chrome plated heavy gauge wire to provide protection.

Glare Hood
Finish: ● Bronze

Guard
Finish: ● Chrome plated



Shown with 9" glare hood

Polycarbonate Shield

1/4" thick clear polycarbonate shield protects lens and lamp. Standoffs securely attach the shield to the cover in minutes.



Wire Guard

Can be used with 4" & 9" glare hood



Replacement Lamps



Ballasts

LHPS250	BHPSH250QT
LHPS400	BHPSH400QT
LMH175MOG	BMHH175QT
LMH200PS	BMHH200PSQ
LMH250	BMHH250QT
LMH250PS	BMHH250PSQ
LMH320PS	BMHH320PSQ
LMH350PS	BMHH350PSQ
LMH400Z	BMHH400QT
LMH400PS	BMHH400PSQ

Catalog Numbers

FZS250QT
FZS400QT

FZH175QT
FZH200PSQ
FZH250QT
FZH250PSQ

FZH320PSQ
FZH350PSQ
FZH400QT
FZH400PSQ

/PC
/PCS
/480

FZS250SFQT
FZS400SFQT

FZH175SFQT
FZH200SFPSQ
FZH250SFQT
FZH250SFPSQ

FZH320SFPSQ
FZH350SFPSQ
FZH400SFQT
FZH400SFPSQ

/PC
/PCS
/480

FZH4 (4" length Glare hood)
FZH9 (9" length Glare hood)
GDFZP (Polycarbonate shield)
GDFZW (Wire Guard)

Dimensions

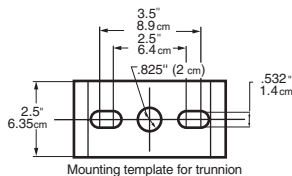
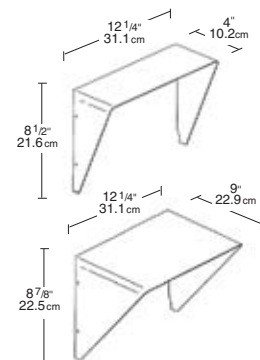
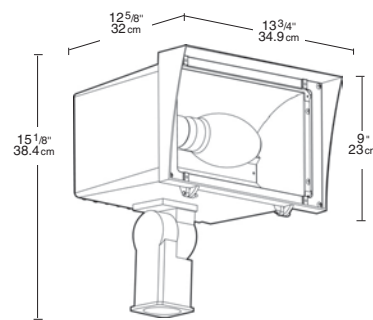
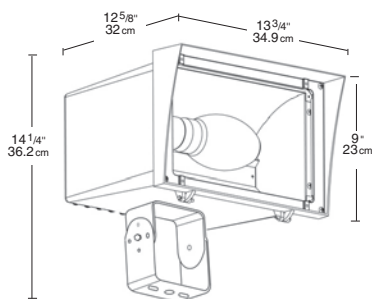

Mounting template for trunnion



Poles, Bullhorns and Mounting Brackets available
See pages 98-103