



Battery Operated Combination Carbon Monoxide & Photoelectric Smoke Alarm

– Alarm/Voice message warning system

– Front loading battery

Part Number CP9000

Model KN-COPE-D

Voice Warning

Warns of hazard by announcing "Fire, Fire" or "Warning, Carbon Monoxide"

Peak Level Memory

Alerts user when the unit has detected CO concentrations of 100ppm or higher

Two LED's

- Red – Alarm mode
- Green – Indicates power is present

Smart Hush™

Silences the unit during nuisance alarm situations (Smoke must be present before hush is activated)

Front Load Battery Door

Alerts user to replace alarm after 10 years of operation



Description

The Kidde Front-Loading Smoke and Carbon Monoxide alarm (part# CP9000) offers protection from two hazards – fire and CO – in one unit. This 9-volt battery powered alarm emits a beeping tone followed by a voice warning that clearly announces the danger by saying, "Fire! Fire!" or "Warning! Carbon Monoxide!" The uniquely designed front-loading battery compartment makes battery replacement quick and easy, and ensures proper installation. Manufactured with a photoelectric sensor for detecting smoke and fire, this alarm also includes the world's most accurate CO sensing technology based on claims by major manufacturers.

Alarm Warnings

Fire: The red LED will flash and be accompanied by three long alarm beeps followed by a verbal warning message "FIRE! FIRE!" The alarm will repeat pattern until unit is reset or smoke is eliminated.

Carbon Monoxide: Four short alarm beeps followed by a verbal warning "WARNING! CARBON MONOXIDE!" After four minutes the alarm/voice pattern will sound once every minute until the unit is reset, or the CO is eliminated.

Low Battery: One chirp followed by warning "LOW BATTERY." The red LED light will flash. This pattern will continue every minute for the first hour. After the first hour the red LED light will flash once every minute accompanied by the chirp sound. The "LOW BATTERY" warning will only sound once every fifteen minutes. This cycle will continue for at least 7 days.

Voice Hush Indication: "HUSH MODE ACTIVATED" and "HUSH MODE CANCELLED" voice announcement

Alarm Memory: The green LED will blink once every 16 seconds to alert a user when the unit has alarmed for smoke or has detected a hazardous concentration of CO. If the alarm has detected a CO level of 100ppm or greater, when the Test/Reset button is pressed the unit will announce "CO PREVIOUSLY DETECTED." If the alarm has detected abnormal levels of smoke since its last test, it will produce three rapid beeps.

Features and Benefits

- **Front-Loading Battery** – Speeds up replacement by eliminating the need to remove the unit from the ceiling or wall.
- **Unique Battery Door Design** – Will not close if battery is not installed properly.
- **Voice Warning** – Supplements warning from the traditional 85-decibel alarm by clearly stating the danger present, fire or carbon monoxide.
- **Photoelectric smoke sensor** – May detect visible fire particles associated with slow smoldering fires sooner than an ionization sensor.
- **Electrochemical CO sensor** – Provides accurate and continual CO protection during the product's life, remains stable during temperature and humidity changes and resists reactions to household gases that may cause false readings or reduce sensitivity.
- **Smart Touch Button** – One button performs the following functions:
 - Activates the Hush® feature to temporarily silence nuisance alarms (will announce "Hush mode activated," or "Hush mode cancelled.")
 - Simultaneously tests the unit's electronics and verifies proper operation
 - Activates the peak level memory feature (will announce "CO previously detected" if unit has detected levels of 100 ppm or higher)
 - Resets the unit during a CO alarm (Unit will re-enter alarm within 6 minutes of reset if 70ppm or more of CO is present).
 - Silences end of life chirp for two days at a time, up to 30 days maximum.
- **Tamper Resistant** – Unit will lock to mounting bracket and battery door will lock to deter theft or tampering.
- **Green LED** – Will flash every 30 seconds to indicate proper operation.
- **Red LED** – Flashes in conjunction with the alarm sounding.
- **End of Life Signal** – Ten years after initial power, the unit will "chirp" twice every 30 seconds to indicate the need to immediately replace the alarm.
- **Low Battery Signal** – Will chirp every minute and red LED will flash to indicate low battery condition.



This alarm uses photoelectric sensing technology. Leading authorities recommend that both ionization and photoelectric smoke alarms be installed to help insure maximum detection of the various types of fires that can occur within the home. Ionization sensing alarms may detect invisible fire particles (associated with fast flaming fires) sooner than photoelectric alarms. Photoelectric sensing alarms may detect visible fire particles (associated with slow smoldering fires) sooner than ionization alarms.

Architectural and Engineering Specifications

The combination smoke and carbon monoxide alarm shall be Kidde Part Number CP9000 (Model KN-COPE-D) or approved equal. It shall be powered by one 9V battery. The temperature operating range shall be between 40°F and 100°F (4°C and 38°C) and the humidity operating range shall be 10% - 95% relative humidity, non condensing.

The unit shall incorporate a photoelectric smoke sensor with nominal sensitivity of 2.5 +/- 0.95%/ft. The CO sensor shall be of a fuel cell design and shall meet the sensitivity requirements of Underwriters Laboratories UL2034 Single and Multiple Station Carbon Monoxide Detectors. The unit shall qualify for UL-approved wording on the package: "World's Most Accurate Carbon Monoxide Alarm."*

The combination alarm can be installed on the surface of any wall or ceiling following the UL/NFPA/Manufacturer's recommended placement guidelines. The unit shall provide optional tamper resistance that deters removal of the unit from the wall or ceiling. No additional pieces shall be required to activate this feature.

The alarm shall include a test button that will electronically simulate the presence of smoke and CO and cause the unit to go into both modes of alarm. This sequence tests the unit's electronics to ensure proper operation. The CO sensor will not alarm to levels of CO below 30 ppm and will alarm in the following time range when exposed to the corresponding levels of CO.

- 70 ppm CO Concentration 60 – 240 minutes
- 150 ppm CO Concentration 10 – 50 minutes
- 400 ppm CO Concentration 4 – 15 minutes

The combination alarm shall have two methods of warning for danger: a piezo-electric horn that is rated at 85 decibels at 10 feet and a voice warning that identifies the danger. For a CO incident, the horn will sound in the repetitive manner – four (4) fast beeps, a short pause, four (4) fast beeps, a short pause. In between, the unit will announce "Warning Carbon Monoxide!" After four minutes the alarm/voice pattern will sound once every minute until the unit is reset, or the CO eliminated. In a Smoke incident, the horn will sound in the repetitive manner – three (3) beeps, a pause, three (3) beeps, a pause. In between, the unit will announce "Fire! Fire!" The unit shall incorporate 2 LED's. A green LED will flash every 30 seconds when in standby condition, every 16 seconds to indicate alarm memory, and every 2 seconds to indicate the Hush™ mode is active. A red LED will flash in unison with the sounder pattern. The unit shall include the Smart Hush™ feature that silences the unit for approximately 8 minutes if a nuisance alarm condition occurs. The Green LED on the alarm will flash every 2 seconds while in Smart Hush™ and will automatically reset itself. Smart Hush™ Feature also provides voice

announcement of "Hush Mode Activated" when Smart Hush™ is activated and "Hush Mode Cancelled" when the Hush cycle ends.

The unit shall also indicate a low battery warning utilizing each of the following methods: a brief alarm chirp, the voice announcement of "Low Battery!" The unit shall at a minimum meet the requirements of UL 2034, UL217, NFPA72, (chapter 11 2002 edition) The State of California Fire Marshall, NFPA101 (One and two family dwellings) Federal Housing Authority (FHA), Housing and Urban Development (HUD). It shall also include a 10-year manufacturer's limited warranty.

*Claim approved by UL, based on manufacturer's reported testing.

Technical Specifications

Part Number:	CP9000
Model:	KN-COPE-D
Power Source:	9V battery
Smoke Sensor:	Photoelectric
CO Sensor:	Electrochemical
Audio Alarm:	85dB at 10ft
Temperature Range:	40°F (4.4°C) to 100°F (37.8°C)
Humidity Range:	10%-95% relative humidity, non-condensing
Size:	5.79" in diameter x 1.85" depth
Weight:	.7lb
Interconnects:	No
Warranty:	10 year limited

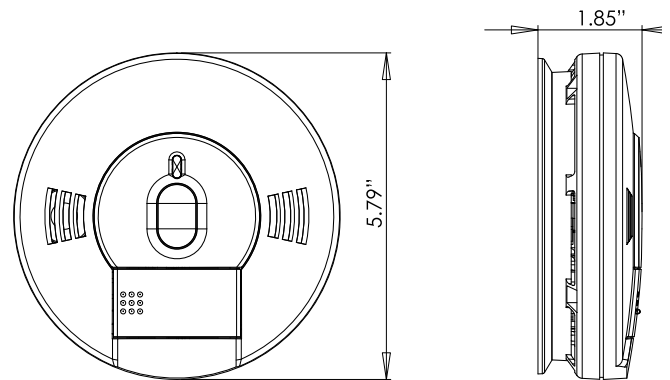

Ordering Information

Ordering Number	UPC	I 2 of 5	Pack Config	Pack Qty	Dimensions (w x d x h inches)	Weight	Cartons/Pallet
21010031	0-47871-10031-6	100-47871-10031-6	CLAM	Cut Case (4 Units)	7.9 x 13.2 x 11.7	1.8	54



1016 Corporate Park Drive
Mebane NC 27302
1-800-880-6788 www.Kidde.com

Distributed by: