

Juno® DanaLite

Undercabinet Lighting

Halogen, Xenon, Fluorescent and LED Undercabinet
and Linear Lighting Solutions



JUNO LIGHTING GROUP
by Schneider Electric

Table of Contents

Pro-Series Undercabinet Lighting

Pro-Series LED	6
Pro-Series Halogen	7
Pro-Series Xenon	8
Pro-Series Fluorescent	9

Economy Undercabinet Lighting

Fluorescent	10
Xenon	11
Line Voltage Halogen	12

Solo-Task LED	15
----------------------	----

Miniature Linear Lighting

DanaLite Modular LED System	17
Trac 12™ Trac-Based Linear Lighting	18

Application Guide	20
--------------------------	----

Product Index	23
----------------------	----





Slim, trim fixtures for undercabinet or shelf lighting...

It's all in the family

Juno's family of undercabinet lighting products offers the industry's most extensive range of options for undercabinet and shelf illumination. But given the amazing diversity and versatility of these fixtures, there is no reason to stop there. Juno's undercabinet family covers an exhaustive array of applications from undercabinet and shelf, to cove, cornice, valence, toe-kick, stair, handrail, task, display, and accent lighting. You name it. No matter what your requirement – residential or commercial – it's all in the family.



Pro-Series Undercabinet Lighting

Fast, trouble-free installation and high-quality design and performance features are the essence of our flagship modular system. Available with a choice of LED, Halogen, Xenon and Fluorescent light sources for virtually any residential and commercial undercabinet and task lighting application.



Economy Undercabinet Lighting

Basic low voltage xenon and fluorescent sheet metal luminaires and the line voltage halogen fixture provide practical alternatives for more budget sensitive installations.



Solo-Task LED Lighting

Diminutive Solo-Task LED luminaires are ideal for task or accent lighting. They feature quick and easy surface or recessed mounting and create high-quality, even, color-consistent illumination. Solo-Task LED luminaires can be installed wherever light is needed and can be easily connected in daisy-chain fashion to provide uniform illumination.

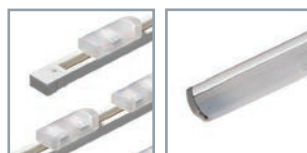

Miniature Linear Lighting

Trac 12™ and DanaLite LED systems are perfect for applications where miniature fixture size and installation versatility are important. By remote mounting the transformer or LED driver, the fixture profiles are minimized making them ideal for integrating into space-constrained undercabinet, in-cabinet, over-cabinet, kick



Juno Pro-Series Fixtures

The combination of installation features, high quality construction and uniform illumination from a variety of light sources make the Pro-Series a best-in-class product from the perspective of the designer, installer and end-user.

Installation

Pro-Series fixtures install in less than five minutes owing to their unique rear-wire access door and captive mounting screws that allow installation without having to open up the wireway or remove the lens. All fixtures include an integral transformer, ballast or driver that allows direct connection to 120-volt supply wires. Additional fixtures in a run simply plug into the first. The Pro-Series installation innovations turn one of the contractor's least favorite fixtures to install into a pleasure.

High Quality Construction

All Pro-Series fixtures maintain a slim 1" extruded aluminum profile available in a variety of lengths and four designer finishes to complement any décor. The extrusion is optimally designed to dissipate heat, to both maximize lamp life and minimize the cabinet contact temperature. A reverse-angled tempered glass prism lens hinges down for relamping and cleaning to provide the optimum mix of safety, simple maintenance, high light transmission and glare control. All these features and more are integrated into an attractive package that will provide years of high-quality, problem-free task lighting.

Light Source Options

Halogen is still the benchmark for high-quality kitchen undercabinet lighting, providing crisp, white light that brings out the sparkle in displayed objects and countertops. Xenon lamps have a slightly warmer color rendition that some designers and homeowners prefer with warmer color palettes. Pro-Series Fluorescent and the latest generation Pro-Series LED models provide cool-to-touch, more energy efficient operation, making them ideal for both residential and more demanding commercial settings. The Pro-Series Fluorescent creates higher levels of bright task lighting while the Pro-Series LED produces high quality illumination with unprecedented energy savings and a 50,000 hour service life.

Pro-Series fixtures feature an easy to conceal 1" profile, reverse angled lightly textured glass diffuser, bright, uniform light distribution, high quality construction features, and a wide selection of finishes.



Pro-Series 5-Minute Direct-Wire Installation



Step 1 Attach supply wires to rear access cover.

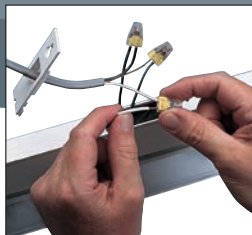

Step 2 Connect supply wires to fixture leads using push-in connectors.



Step 3 Mount fixture to cabinet bottom using captive mounting screws.

Pro-Series Energy Comparison

Fixture Length	Pro-Series Halogen/ Pro-Series Xenon	Pro-Series Fluorescent	Pro-Series LED
9"	20 watts		3.8 watts
14" (12" Fluorescent)	40 watts	8.4 watts	6.5 watts
22"	60 watts	15.3 watts	10.0 watts
30" (34" Fluorescent)	80 watts	22.1 watts	12.1 watts

LED



Juno's Pro-Series LED duplicates the light level and color of Halogen undercabinet lighting using just 1/6 of the energy and virtually no heat. And by virtue of its amazing 50,000 hour life, lamp replacement is a thing of the past...at 4 hours/day you can expect over 34 years of maintenance-free operation!

Performance Features

- Utilizes warm-white 3000K LEDs tightly binned to within 2-step MacAdam Ellipse for industry-leading color consistency
- Approximates the color temperature and work surface illumination levels of halogen using 1/6 of the wattage
- Dimmable with most incandescent, magnetic low voltage or electronic low voltage wall box dimmers.
- 70% of initial illumination at end of 50,000 hour rated life... LEDs will not burn out
- Cool to touch operation with virtually no heat on the cabinet bottom
- No UV or forward projected heat

Construction Features

- Slim 1" extruded aluminum profile
- Premium clear prismatic tempered glass lens for maximum light transmission and wipe down cleaning. Reversed angled to minimize perceived fixture brightness
- Hinged lens captured by spring loaded retention bar can not accidentally fall out
- Integral state of the art 120-volt constant current electronic driver
- Integral on/off rocker switch
- Contains no mercury
- Choice of Designer White, Brushed Silver, Brushed Bronze or Black finish

Installation Features

- Modular design for maximum flexibility and quick installation allows up to 40 fixtures to plug together using the supplied internal straight connector or optional jumper cords
- Captive external mounting screws
- Rear wireway access cover with flush non-metallic cable clamp and push-in electrical connectors facilitate fast wiring without having to open fixture (14", 22", and 30" only)
- Miniature die-cast fitting for flexible metal conduit, off-center knock-outs and extra mounting plate for feed-through fixture-to-fixture loop wiring increase installation versatility (14", 22", and 30" only)



Fixtures

UPLED09 – 9" Pro-Series LED

Supplied with joiner connector, mounting hardware and two (2) 1W LEDs.
9-1/2" L x 4-1/2" D x 1" H

Finish: BL-Black, BZ-Brushed Bronze, SL-Brushed Silver, WH-Designer White

UPLED14 – 14" Pro-Series LED

Supplied with joiner connector, mounting hardware and four (4) 1W LEDs.
14" L x 4-1/2" D x 1" H

Finish: BL-Black, BZ-Brushed Bronze, SL-Brushed Silver, WH-Designer White

UPLED22 – 22" Pro-Series LED

Supplied with joiner connector, mounting hardware and six (6) 1W LEDs.
22" L x 4-1/2" D x 1" H

Finish: BL-Black, BZ-Brushed Bronze, SL-Brushed Silver, WH-Designer White

UPLED30 – 30" Pro-Series LED

Supplied with joiner connector, mounting hardware and eight (8) 1W LEDs.
29-1/4" L x 4-1/2" D x 1" H

Finish: BL-Black, BZ-Brushed Bronze, SL-Brushed Silver, WH-Designer White

Accessories

JC3-8 (8"), JC3-17 (17"), JC3-26 (26") – Jumper Cords

3-wire Jumper Cord to electrically join fixtures when spaced apart, turning corners, or spanning cabinet frames.

Finish: BL-Black, WH-Designer White

ULH-CP – 6' Cord and Plug

3-wire grounded cord and plug accessory for portable plug-in installation.

Finish: BL-Black, WH-Designer White

ULH-DWM – Direct Wire Module

Facilitates code-compliant installation of fixture at front edge of cabinet. Includes wiring enclosure and 36" field-shortenable jumper cord that plugs into the right or left side of the fixture.
3" L x 3" D x 1" H

Finish: BL-Black, WH-Designer White

ULH-CONN – 3/8" Miniature Die-Cast Electrical Connector

Accessory for use when loop wiring with non-metallic sheathed cable or BX



Finishes



Black

Brushed Bronze

Brushed Silver

Designer White

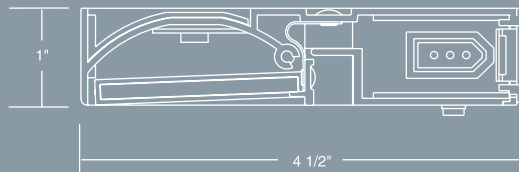



Halogen

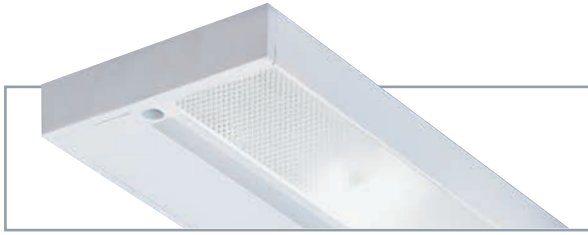

Pro-Series Halogen is the original and ever-popular Pro-Series fixture. True-halogen color rendering in a slim, attractive package designed to maximize light output and minimize the cabinet bottom contact temperature. Extended 6,000 hour lamp life is achieved by tuning the output voltage to the halogen lamp.

Performance Features

- 12-volt halogen lamps for optimal color rendering
- 6,000+ hour lamp life
- Integral reflector spaced away from cabinet bottom maximizes light output while reducing fixture/cabinet contact temperature
- Dimmable with standard ELV type wall box dimmers or integral high/low/off rocker switch

Construction Features

- Slim 1" extruded aluminum profile
- Premium clear prismatic tempered glass lens for maximum light transmission and wipe down cleaning is reversed angled to minimize perceived fixture brightness
- Hinged lens captured by spring loaded retention bar can not accidentally fall out
- Integral state of the art 120 to 12-volt electronic transformer
- Choice of Designer White, Brushed Silver, Brushed Bronze or Black finish

Installation Features

- Modular design for maximum flexibility and quick installation allows up to 10 fixtures to plug together using the supplied internal straight connector or optional jumper cords
- Captive external mounting screws
- Rear wireway access cover with flush non-metallic cable clamp and push-in electrical connectors facilitate fast wiring without having to open fixture
- Miniature die-cast fitting for flexible metal conduit, off-center knock-outs and extra mounting plate for feed-through fixture-to-fixture loop wiring increase installation versatility



Fixtures

ULH109 – 9" 1-Lamp Pro-Series Halogen
 Supplied with joiner connector, mounting hardware and (1) T3 12V 20W bi-pin halogen lamp.
 9-1/2"L x 4-1/2"D x 1"H

Finish: BL-Black, BZ-Brushed Bronze, SL-Brushed Silver, WH-Designer White

ULH214 – 14" 2-Lamp Pro-Series Halogen

Supplied with joiner connector, mounting hardware and (2) T3 12V 20W bi-pin halogen lamps.
 14"L x 4-1/2"D x 1"H

Finish: BL-Black, BZ-Brushed Bronze, SL-Brushed Silver, WH-Designer White

ULH322 – 22" 3-Lamp Pro-Series Halogen

Supplied with joiner connector, mounting hardware and (3) T3 12V 20W bi-pin halogen lamps.
 22"L x 4-1/2"D x 1"H

Finish: BL-Black, BZ-Brushed Bronze, SL-Brushed Silver, WH-Designer White

ULH430 – 30" 4-Lamp Pro-Series Halogen

Supplied with joiner connector, mounting hardware and (4) T3 12V 20W bi-pin halogen lamps.
 29-1/4"L x 4-1/2"D x 1"H

Finish: BL-Black, BZ-Brushed Bronze, SL-Brushed Silver, WH-Designer White

Accessories

JC3-8 (8"), JC3-17 (17"), JC3-26 (26") – Jumper Cords

3-wire Jumper Cord to electrically join fixtures when spaced apart, turning corners, or spanning cabinet frames.

Finish: BL-Black, WH-Designer White

ULH-CP – 6' Cord and Plug

3-wire grounded cord and plug accessory for portable plug-in installation.

Finish: BL-Black, WH-Designer White

ULH-DWM – Direct Wire Module

Facilitates code-compliant installation of fixture at front edge of cabinet. Includes wiring enclosure and 36" field-shortenable jumper cord that plugs into the right or left side of the fixture.
 3"L x 3"D x 1"H

Finish: BL-Black, WH-Designer White

ULH-CONN – 3/8" Miniature Die-Cast Electrical Connector

Accessory for use when loop wiring with non-metallic sheathed cable or BX.

TL923 – 12V 20W bi-pin, high-output halogen Replacement lamp

Finishes



Black

Brushed Bronze

Brushed Silver

Designer White

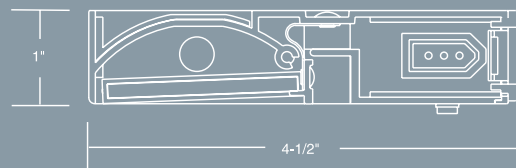

Listings UL/C-UL

Cabinet Bottom Contact Temperatures

Typical Halogen Fixture
 Between 70 – 90°C
 Causes cabinetry discoloration/delaminating and drying out of perishables stored on shelf above

Pro-Series Halogen Fixture
 Under 60°C
 Safe for most cabinet laminates and minimizes thermal transfer to shelf above

Xenon

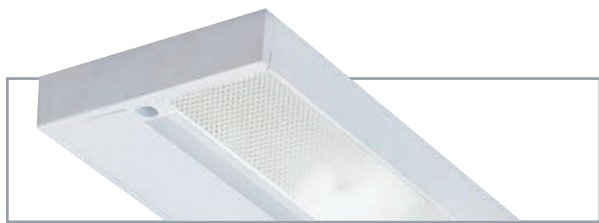

Pro-Series Xenon offers a slightly warmer color rendering than halogen in the same attractive, efficient Pro-Series package designed to maximize light output and minimize the cabinet bottom contact temperature. 10,000 hour lamp life is achieved by tuning the output voltage to the xenon lamp.

Performance Features

- 12-volt xenon lamps offer slightly warmer color rendering as compared to halogen
- 10,000 hour lamp life
- Integral reflector spaced away from cabinet bottom maximizes light output while reducing fixture/cabinet contact temperature
- Dimmable with standard ELV type wall box dimmers or integral high/low/off rocker switch

Construction Features

- Slim 1" extruded aluminum profile
- Premium clear prismatic tempered glass lens for maximum light transmission and wipe down cleaning is reversed angled to minimize perceived fixture brightness
- Hinged lens captured by spring loaded retention bar can not accidentally fall out
- Integral state of the art 120 to 12-volt electronic transformer
- Choice of Designer White, Brushed Silver, Brushed Bronze or Black finish

Installation Features

- Modular design for maximum flexibility and quick installation allows up to 10 fixtures to plug together using the supplied internal straight connector or optional jumper cords
- Captive external mounting screws
- Rear wireway access cover with flush non-metallic cable clamp and push-in electrical connectors facilitate fast wiring without having to open fixture
- Miniature die-cast fitting for flexible metal conduit, off-center knock-outs and extra mounting plate for feed-through fixture-to-fixture loop wiring increase installation versatility



Fixtures

UPX109 – 9" 1-Lamp Pro-Series Xenon

Supplied with joiner connector, mounting hardware and (1) 12V 20W bi-pin high output xenon lamp. 9-1/2"L x 4-1/2"D x 1"H

Finish: BL-Black, BZ-Brushed Bronze, SL-Brushed Silver, WH-Designer White

UPX214 – 14" 2-Lamp Pro-Series Xenon

Supplied with joiner connector, mounting hardware and (2) 12V 20W bi-pin high output xenon lamps. 14"L x 4-1/2"D x 1"H

Finish: BL-Black, BZ-Brushed Bronze, SL-Brushed Silver, WH-Designer White

UPX322 – 22" 3-Lamp Pro-Series Xenon

Supplied with joiner connector, mounting hardware and (3) 12V 20W bi-pin high output xenon lamps. 22"L x 4-1/2"D x 1"H

Finish: BL-Black, BZ-Brushed Bronze, SL-Brushed Silver, WH-Designer White

UPX430 – 30" 4-Lamp Pro-Series Xenon

Supplied with joiner connector, mounting hardware and (4) 12V 20W bi-pin high output xenon lamps. 30"L x 4-1/2"D x 1"H

Finish: BL-Black, BZ-Brushed Bronze, SL-Brushed Silver, WH-Designer White



Accessories

JC3-8 (8"), JC3-17 (17"), JC3-26 (26") – Jumper Cords

3-wire Jumper Cord to electrically join fixtures when spaced apart, turning corners, or spanning cabinet frames.

Finish: BL-Black, WH-Designer White

ULH-CP – 6' Cord and Plug

3-wire grounded cord and plug accessory for portable plug-in installation.

Finish: BL-Black, WH-Designer White

ULH-DWM – Direct Wire Module

Facilitates code-compliant installation of fixture at front edge of cabinet. Includes wiring enclosure and 36" field-shortenable jumper cord that plugs into the right or left side of the fixture. 3"L x 3"D x 1"H

Finish: BL-Black, WH-Designer White

ULH-CONN – 3/8" Miniature Die-Cast Electrical Connector

Accessory for use when loop wiring with non-metallic sheathed cable or BX.

UPX-LAMP – 12V 20W bi-pin, high-output xenon Replacement lamp

Finishes



Black

Brushed Bronze

Brushed Silver

Designer White

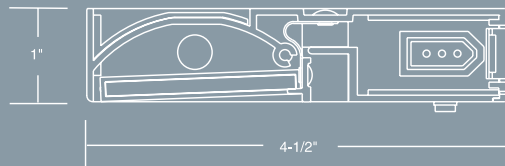



Fluorescent



Pro-Series Fluorescent offers a cool-operating, energy efficient solution with work surface light levels up to 50% higher than other Pro-Series lamping options. It is an ideal choice for uniform, shadow free task lighting in both residential and commercial applications.

Performance Features

- Fixtures include cool operating, energy efficient 3000K high-color rendering T5 fluorescent lamp
- 10,000 hour rated lamp life
- Bright, uniform, shadow free illumination

Construction Features

- Slim 1" extruded aluminum profile
- Premium UV stabilized acrylic diffuser remains pliable and will not discolor
- Solid front design minimizes perceived fixture brightness
- Integral on/off rocker switch
- State of the art 120-volt electronic ballast provides instant lamp starting and quiet, flicker-free operation
- Choice of Designer White, Brushed Silver, Brushed Bronze or Black finish

Installation Features

- Modular design for maximum flexibility and quick installation allows up to 10 fixtures to plug together using the supplied internal straight connector or optional jumper cords
- Captive external mounting screws
- Rear wireway access cover with flush non-metallic cable clamp and push-in electrical connectors facilitate fast wiring without having to open fixture
- Miniature die-cast fitting for flexible metal conduit, off-center knock-outs and extra mounting plate for feed-through fixture-to-fixture loop wiring increase installation versatility

Pro-Series Fluorescent light output compared to Halogen

Pro-Series Fluorescent (Lamp Wattage)	Halogen wattage producing equivalent light output
8 watts	40 watts
14 watts	75 watts
21 watts	100 watts
28 watts	150 watts



Fixtures

UPF12 – 12" 8W T5 Direct Wire Fluorescent
Supplied with 8W T5 3000K tri-phosphor lamp, mounting hardware and 3/8" miniature die-cast electrical connector.

Finish: BL-Black, BZ-Brushed Bronze, SL-Brushed Silver, WH-Designer White



UPF22 – 22" 14W T5 Direct Wire Fluorescent
Supplied with 14W T5 HE 3000K tri-phosphor lamp, mounting hardware and 3/8" miniature die-cast electrical connector.

22-3/4"L x 4-1/2"D x 1"H

Finish: BL-Black, BZ-Brushed Bronze, SL-Brushed Silver, WH-Designer White



UPF34 – 34" 21W T5 Direct Wire Fluorescent
Supplied with 21W T5 HE 3000K tri-phosphor lamp, mounting hardware and 3/8" miniature die-cast electrical connector.

34-1/2"L x 4-1/2"D x 1"H

Finish: BL-Black, BZ-Brushed Bronze, SL-Brushed Silver, WH-Designer White

UPF46 – 46" 28W T5 Direct Wire Fluorescent
Supplied with 28W T5 HE 3000K tri-phosphor lamp, mounting hardware and 3/8" miniature die-cast electrical connector.

46-5/16"L x 4-1/2"D x 1"H

Finish: BL-Black, BZ-Brushed Bronze, SL-Brushed Silver, WH-Designer White

Accessories

JC3-8 (8"), JC3-17 (17"), JC3-26 (26") – Jumper Cords

3-wire Jumper Cord to electrically join fixtures when spaced apart, turning corners, or spanning cabinet frames.

Finish: BL-Black, WH-Designer White



ULH-CP – 6' Cord and Plug

3-wire grounded cord and plug accessory for portable plug-in installation.

Finish: BL-Black, WH-Designer White



ULH-DWM – Direct Wire Module

Facilitates code-compliant installation of fixture at front edge of cabinet. Includes wiring enclosure and 36" field-shortenable jumper cord that plugs into the right or left side of the fixture.

3"L x 3"D x 1"H

Finish: BL-Black, WH-Designer White



ULH-CONN – 3/8" Miniature Die-Cast Electrical Connector

Accessory for use when loop wiring with non-metallic sheathed cable or BX



Finishes



Black

Brushed Bronze

Brushed Silver

Designer White

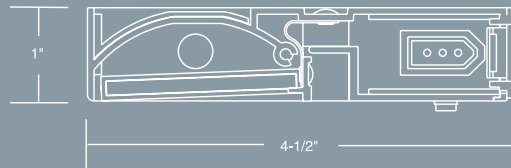

Fluorescent



The economy fluorescent series offers a cool-operating, energy efficient solution with work surface light levels up to 50% higher than other lamping options in a basic sheet metal housing with wrap-around diffuser. It is an ideal choice for uniform, shadow free task lighting in both residential and commercial applications.

Performance Features

- Fixtures include cool operating, energy efficient 3000K high-color rendering T5 fluorescent lamp
- 10,000 hour rated lamp life
- Bright, uniform shadow free illumination

Construction Features

- Compact 2-5/16" D x 1-1/16" H sheet metal profile
- Premium UV stabilized acrylic wrap-around diffuser remains pliable and will not discolor
- Integral on/off rocker switch
- State of the art 120-volt electronic ballast provides instant lamp starting and quiet, flicker-free operation
- Choice of Appliance White or Silver painted finishes

Installation Features

- Multiple electrical knock-outs in back and sides to facilitate direct wire installation



Fixtures

UFL12 – 12" 8W T5 Direct Wire Fluorescent
Supplied with 8W T5 3000K tri-phosphor lamp, mounting hardware and 3/8" miniature die-cast electrical connector.

12-7/16" L x 2 5/8" D x 1-1/16" H

Finish: SL-Silver, WH-Appliance White



UFL22 – 22" 14W T5 Direct Wire Fluorescent
Supplied with 14W T5 HE 3000K tri-phosphor lamp, mounting hardware and 3/8" miniature die-cast electrical connector.

22-3/4" L x 2 5/8" D x 1-1/16" H

Finish: SL-Silver, WH-Appliance White



UFL34 – 34" 21W T5 Direct Wire Fluorescent
Supplied with 21W T5 HE 3000K tri-phosphor lamp, mounting hardware and 3/8" miniature die-cast electrical connector.

34-1/2" L x 2 5/8" D x 1-1/16" H

Finish: SL-Silver, WH-Appliance White



UFL46 – 46" 28W T5 Direct Wire Fluorescent
Supplied with 28W T5 HE 3000K tri-phosphor lamp, mounting hardware and 3/8" miniature die-cast electrical connector.

46-5/16" L x 2 5/8" D x 1-1/16" H

Finish: SL-Silver, WH-Appliance White



Accessories

ULH-CP – 6' Cord and Plug

3-wire grounded cord and plug accessory for portable plug-in installation.

Finish: BL-Black, WH-Designer White



ULH-CONN – 3/8" Miniature Die-Cast Electrical Connector

Accessory for use when loop wiring with non-metallic sheathed cable or BX

Finishes



Silver



Appliance White

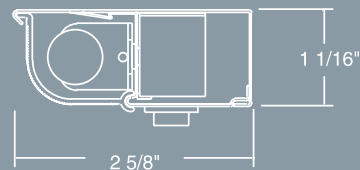

Listings UL/C-UL

Note: Juno economy series fluorescent fixtures are not dimmable

Xenon



The warmth of xenon undercabinet lighting in a basic sheet metal housing.

Performance Features

- 12-volt xenon lamps offer slightly warmer color rendering as compared to halogen
- 10,000 hour lamp life
- Dimmable with standard ELV type wall box dimmers or integral high/low/off rocker switch.

Construction Features

- Compact 3-1/2" D x 1-3/16" H sheet metal profile
- Slide-in frosted tempered glass lens
- Integral state of the art 120 to 12-volt electronic transformer
- Appliance White finish

Installation Features

- Multiple electrical knock-outs on back and sides to facilitate direct wire installation



Fixtures

ULX109-WH – 9" Direct Wire 1-Lamp Xenon
 Supplied with (1)18W T5 wedge base xenon lamp, mounting hardware and 3/8" miniature die-cast electrical connector.
 9-1/2" L x 3-1/2" D x 1 3/16" H
Finish: Appliance White

ULX212-WH – 12" Direct Wire 2-Lamp Xenon
 Supplied with (2)18W T5 wedge base xenon lamps, mounting hardware and 3/8" miniature die-cast electrical connector.
 12" L x 3-1/2" D x 1 3/16" H
Finish: Appliance White

ULX318-WH – 18" Direct Wire 3-Lamp Xenon
 Supplied with (3)18W T5 wedge base xenon lamps, mounting hardware and 3/8" miniature die-cast electrical connector.
 18" L x 3-1/2" D x 1 3/16" H
Finish: Appliance White

ULX424-WH – 24" Direct Wire 4-Lamp Xenon
 Supplied with (4)18W T5 wedge base xenon lamps, mounting hardware and 3/8" miniature die-cast electrical connector.
 24" L x 3-1/2" D x 1 3/16" H
Finish: Appliance White

Accessories

ULH-CP – 6' Cord and Plug
 3-wire grounded cord and plug accessory for portable plug-in installation.
Finish: BL-Black, WH-Designer White

ULH-CONN – 3/8" Miniature Die-Cast Electrical Connector
 Accessory for use when loop wiring with non-metallic sheathed cable or BX

Finishes



Appliance White

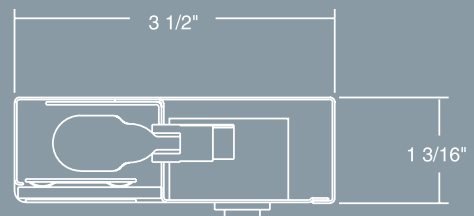

Listings UL/C-UL

Line Voltage Halogen



Provides economical halogen lighting by utilizing 120-volt halogen lamps which do not require a transformer.

Performance Features

- Economical 120-volt, 25-watt halogen lamps provide a somewhat warmer tone than low voltage halogen lamps
- 2,000 hour lamp life
- Dimmable with standard incandescent wall box dimmers or integral high/low/off rocker switch

Construction Features

- Compact 3"D x 1-5/16"H extruded aluminum profile
- Internal specular reflector maximizes light output while managing fixture/cabinet contact temperature
- Slide-in frosted tempered glass lens
- Designer White finish

Installation Features

- Modular design is optimized for portable plug-in installations and plug-together connection of multiple fixtures
- May be permanently direct wired using optional Direct Wire Module
- Captive external mounting screws



Fixtures

UH106-WH – 6" 1-Lamp Line Voltage Halogen

Supplied with field-shortenable 6' cord and plug, joiner connector, (1) G8 120V 25W bi-pin halogen lamp, and mounting hardware.

6-1/8" L x 3"D x 1-5/16" H
(Add 2" to length for side entry of power cord.)

Finish: Designer White



UH212-WH – 12" 2-Lamp Line Voltage Halogen

Supplied with field-shortenable 6' cord and plug, joiner connector, (2) G8 120V 25W bi-pin halogen lamps, and mounting hardware.

12-1/8" L x 3"D x 1-5/16" H
(Add 2" to length for side entry of power cord.)

Finish: Designer White



UH318-WH – 18" 3-Lamp Line Voltage Halogen

Supplied with field-shortenable 6' cord and plug, joiner connector, (3) G8 120V 25W bi-pin halogen lamps, and mounting hardware.

17-3/4" L x 3"D x 1-5/16" H
(Add 2" to length for side entry of power cord.)

Finish: Designer White



Accessories

DWM1-WH – Direct Wire Module

Required for permanent wiring of Line Voltage Halogen fixtures. Includes wiring enclosure and 36" field-shortenable jumper cord to bring power to right or left side of the fixture.

3" L x 3" D x 1" H

Finish: Designer White



JC2-8 (8"), JC2-17 (17"), JC2-26 (26") – Jumper Cords

2-wire Jumper Cord to electrically join fixtures when spaced apart, turning corners, or spanning cabinet frames.

Finish: Designer White



T925 – Replacement Lamp

G8 120V 25W Bi-pin halogen lamp

Line Voltage Halogen Installation Options



Portable Installation



Direct Wire Installation

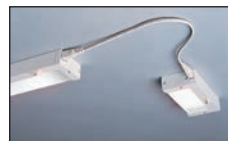

Joining Multiple Fixtures



Joining Multiple Fixtures

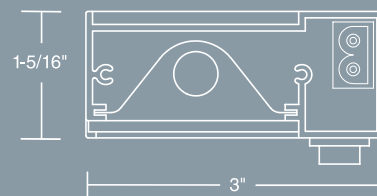



Solo-Task LED Undercabinet Lighting

Solo-Task LED ultra-compact, super efficient luminaires are ideal for task and accent lighting. These stylish fixtures are available in four beautiful finishes ... designer white, satin nickel, brushed bronze, and black. They are the perfect enhancement to a wide variety of residential and commercial décors.



Solo-Task



Juno Solo-Task LED luminaires are the mighty-mite of undercabinet lighting. At less than 3" in diameter, and with a low 9/16" profile, they fit unobtrusively under cabinets and shelves, yet produces an impressive 205 lumens of bright white light for task and accent applications.

Performance Features

- White Phosphor LED array provides outstanding performance, color quality, color consistency and color reliability
- Consumes just 4.3-watts*
- 3000K Color temperature, 85 CRI
- Approximates the light levels of 20-watt halogen and xenon light sources while using 1/4 of the energy
- High-transmission diffusing lens produces smooth, uniform aperture luminance
- Dimmable with electronic low voltage dimmers (when used with TL602E) and magnetic low voltage dimmers (when used with TL576)
- No UV or forward projected heat
- Five year warranty

* Represents Solo-Task LED power – additional losses vary depending upon driver chosen and system loading

Drivers/Transformers

	Catalog #	Finish	Description
	TL602E-10-WH	White	10W 12V AC (Class-2) Electronic Driver/Transformer
	TL602E-25-WH	White	25W 12V AC (Class-2) Electronic Driver/Transformer
	TL602E-60-WH	White	60W 12V AC (Class-2) Electronic Driver/Transformer
	TL548U-WH	White	60W 12V AC (Class-2) Plug-in Electronic Driver/Transformer
	TL548U-BL	Black	60W 12V AC (Class-2) Plug-in Electronic Driver/Transformer
	TL576-10-BL	Black	10W 12V AC (Class-2) Magnetic Driver/Transformer
	TL576-25-BL	Black	25W 12V AC (Class-2) Magnetic Driver/Transformer
	TL576-60-BL	Black	60W 12V AC (Class-2) Magnetic Driver/Transformer

Ordering Options (Add as suffix to catalog numbers TL602E or TL576)

Catalog #	Finish	Description
-CP6	White	6ft. Cord & Plug, factory installed

The Solo-Task LED luminaire offering is a low voltage system. As such, voltage drop is an inherent characteristic. Refer to the Solo-Task LED specification sheet or installation instructions for system run lengths utilizing the above driver/transformers to ensure optimal system performance.

Accessories

Catalog #	Description
UST18G-10-WH	18AWG 2-Conductor Parallel Bonded Wire, 10-Feet, White
UST18G-25-WH	18AWG 2-Conductor Parallel Bonded Wire, 25-Feet, White
UST18G-10-BL	18AWG 2-Conductor Parallel Bonded Wire, 10-Feet, Black
UST18G-25-BL	18AWG 2-Conductor Parallel Bonded Wire, 25-Feet, Black
USTL-REC-BL	Kit to convert Surface Mount to Recessed Mount, Black
USTL-REC-BZ	Kit to convert Surface Mount to Recessed Mount, Brushed Bronze
USTL-REC-SN	Kit to convert Surface Mount to Recessed Mount, Satin Nickel
USTL-REC-WH	Kit to convert Surface Mount to Recessed Mount, White

Construction Features

- Small 2-1/2" diameter (2-29/32" recessed mount) with low 9/16" profile
- Quality die cast aluminum
- Available in surface mount or recessed mount configurations
- High transmission diffusing lens
- Onboard luminaire LED driver
- Choice of Designer White, Black, Brushed Bronze and Satin Nickel finishes

Installation Features

- Can be individually mounted or connected in daisy-chain fashion, making installation simple and straightforward
- Requires a single, local or remote, 120V AC to 12V AC electronic or magnetic Juno transformer
- Convenient all-in-one kit is also available

Surface Mount Fixtures

	USTL1-3K-WH 4.3 watt/3000K Finish: White Face/ White Plate		USTL1-3K-SN 4.3 watt/3000K Finish: Satin Nickel Face/ Black Plate
	USTL1-3K-BZ 4.3 watt/3000K Finish: Brushed Bronze Face/ Black Plate		USTL1-3K-BL 4.3 watt/3000K Finish: Black Face/ Black Plate

Recessed Mount Fixtures

	USTLR1-3K-WH 4.3 watt/3000K Finish: White Face/ White Plate		USTLR1-3K-SN 4.3 watt/3000K Finish: Satin Nickel Face/ Black Plate
	USTLR1-3K-BZ 4.3 watt/3000K Finish: Brushed Bronze Face/ Black Plate		USTLR1-3K-BL 4.3 watt/3000K Finish: Black Face/ Black Plate

Solo-Task Kits

Each kit includes: (3) surface mount luminaires, (1) plug-in driver / transformer with field installed switch, 10-feet of wire, and (5) adhesive backed wire clips



UK35TL-3K-BL
14.3 watts/3000K
Finish: Black Face/Black Plate

UK35TL-3K-BZ
14.3 watts/3000K
Finish: Brushed Bronze Face/Black Plate

UK35TL-3K-SN
14.3 watts/3000K
Finish: Satin Nickel Face/Black Plate

UK35TL-3K-WH
14.3 watts/3000K
Finish: White Face/White Plate

Miniature Linear Lighting Solutions

Trac 12™ and DanaLite LED systems are perfect for applications where miniature fixture size and increased installation versatility are required. By remote mounting the transformer or LED driver, the fixture profiles are minimized making them ideal for integrating into space-constrained undercabinet, in-cabinet, over-cabinet, kick-space, shelving, display and cove applications. DanaLite LED modular fixtures integrate the latest LED technology into an ultra-compact 1" wide x ½" tall profile. Trac 12 features field cut-to-length capability with adjustable xenon, halogen and LED lampholder spacing for the ultimate in customization.



Modular LED Systems



A true breakthrough in linear lighting, the DL106 and DL112 series integrate the latest low power LED technology into an ultra-slim, modular luminaire that delivers up to 263 lumens per foot of high quality illumination. At 1/2" deep, these luminaires can easily integrate into casework and architectural details, making them ideal for a wide variety of linear lighting applications.

Performance Features

- Nichia brand LEDs for maximum reliability, performance and color quality/consistency
- 70% of initial illumination at end of 50,000 hour rated life... LEDs will not burn out
- Efficacies up to 53 lumens per watt provides comparable light output to halogen sources using less than 1/8 the energy with no forward projected heat
- 3000K, 4100K and 5000K color temperatures (85 CRI standard)
- High CRI 3000K option makes reds "pop" in color critical applications (92 CRI)
- Cool to touch operation with no UV or forward projected heat
- Clear lens for maximum efficiency or frosted lens for diffuse illumination and source obscuration

Construction Features

- Ultra-slim 1/2"H x 1"D profile
- Efficient LED heat sinking to extruded aluminum base
- Integral on-board current regulator assures all modules in a run produce the same light output
- RoHS compliant; contains no mercury, lead or PCBs

Installation Features

- 6" and 12" plug-together modules simplify ordering and installation
- Dimmable and non-dimmable Class 2 24V DC remote drivers power runs from 1' to 16'
- Jumper cables facilitate cabinetry installations and curved patterns
- Optional fascia shield and 45° angle mounting extrusions

LED Modules

DL106-3-C – Two 3000K 1-watt LEDs

Supplied with clear lens and mounting screws.
1/2"H x 1"W x 5-1/2"L

DL106-4-C – Two 4100K 1-watt LEDs

Supplied with clear lens and mounting screws.
1/2"H x 1"W x 5-1/2"L

DL106-5-C – Two 5000K 1-watt LEDs

Supplied with clear lens and mounting screws.
1/2"H x 1"W x 5-1/2"L

DL106-3H-C – Two 3000K 1-watt High CRI LEDs

Supplied with clear lens and mounting screws.
1/2"H x 1"W x 5-1/2"L

DL112-3-C – Four 3000K 1-watt LEDs

Supplied with clear lens and mounting screws.
1/2"H x 1"W x 11-1/2"L

DL112-4-C – Four 4100K 1-watt LEDs

Supplied with clear lens and mounting screws.
1/2"H x 1"W x 11-1/2"L

DL112-5-C – Four 5000K 1-watt LEDs

Supplied with clear lens and mounting screws.
1/2"H x 1"W x 11-1/2"L

DL112-3H-C – Four 3000K 1-watt High CRI LEDs

Supplied with clear lens and mounting screws.
1/2"H x 1"W x 11-1/2"L

For frosted lens:

Change "C" in catalog number to "F", example: DL106-3-F

Power Cable and End-Caps

(1 of each required for each run)

DL101-P

118" Starter Power Cable

DL101-E

End-Cap

Connectors

DL102-EE – End-to-End Connector

Joins two fixtures together in a straight run

DL102-FLX2

2-1/2" Flexible End-to-End Connector

DL102-FLX37

37" Flexible End-to-End Connector

DL1010-TB – Terminal Block Connector

Allows custom length field connections

Remote Drivers

(1 driver required for each run)

Non-Dimmable

DL17-120-WH/BL – 17-watt, 24V-DC Non-Dimmable Remote Mount Electronic Driver with switch
120-volt input. No minimum load.
7"L x 2-1/2"D x 1-5/8"H

Finishes: WH-White, BL-Black

DL25-WH/BL – 25-watt, 24V-DC Non-Dimmable Remote Mount Electronic Driver with switch
Universal 120-277-volt input. No minimum load.
7"L x 2-1/2"D x 1-5/8"H

Finishes: WH-White, BL-Black

DL80-120 – 80-watt, 24V-DC Non-Dimmable Remote Mount Electronic Driver with switch
120-volt input. No minimum load.
16"L x 3-3/8"D x 2-1/4"H

Finish: Natural Aluminum

DL100 – 100-watt, 24V-DC Non-Dimmable Remote Mount Electronic Driver with switch
Universal 120-277-volt input. No minimum load.
16"L x 3-3/8"D x 2-1/4"H

Finish: Natural Aluminum

Dimmable*

DL17-120-DIM – 17-watt, 24V-DC Dimmable Remote Mount Electronic Driver with switch
120-volt input. No minimum load.
9"L x 3-3/8"D x 2-1/4"H

Finish: Natural Aluminum

DL25-DIM – 25-watt, 24V-DC Dimmable Remote Mount Electronic Driver with switch
Universal 120-277-volt input. No minimum load.
9"L x 3-3/8"D x 2-1/4"H

Finish: Natural Aluminum

DL60-DIM – 60-watt, 24V-DC Dimmable Remote Mount Electronic Driver with switch
Universal 120-277-volt input. No minimum load.
16"L x 3-3/8"D x 2-1/4"H

Finish: Natural Aluminum

DL100-DIM – 100-watt, 24V-DC Dimmable Remote Mount Electronic Driver with switch
Universal 120-277-volt input. No minimum load.
16"L x 3-3/8"D x 2-1/4"H

Finish: Natural Aluminum

* Dimmable with approved dimmers, please refer to specification sheet

Accessory Mounting Extrusions

DL103-MS48-S / DL103-MS96-S

Mounting Shield Extrusion.
1-1/8"D x 1"H Lengths: 48" or 96"
Finish: Satin Aluminum

DL103-AME48-S / DL103-AME96-S

45-degree Angled Mounting Extrusion.
1"D x 1"H Lengths: 48" or 96"
Finish: Satin Aluminum

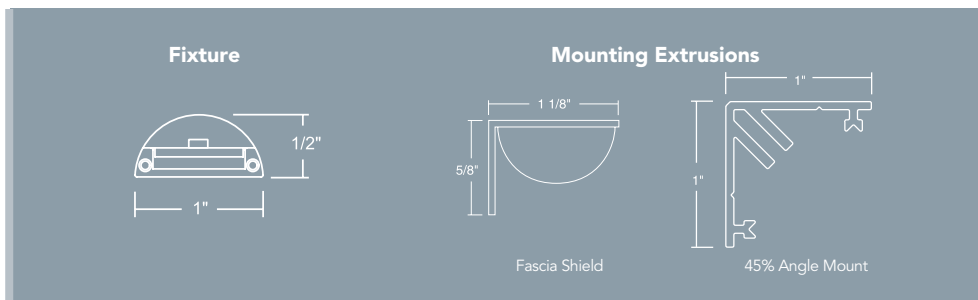

Listings UL/C-UL

Linear Lighting

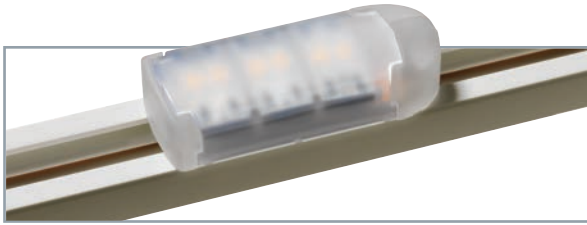

Trac 12 LED



Trac 12 Xenon

Trac 12 is a miniature profile low voltage trac system that combines variable lampholder spacing and field cut-to-length customization. Available with LED, Xenon and Halogen lamping options, Trac 12 is a versatile system that can satisfy a variety of linear lighting applications.

Trac 12 System Features

- Selection of LED and Xenon linear lampholders can be spaced as tightly as 2-1/4" OC
- Maintains less than 1" overall profile using either LED or Xenon lampholders
- Trac can be easily and quickly field configured to any pattern and cut-to-length
- Broad selection of compact electronic and larger capacity magnetic transformers/drivers

Trac 12 LED Lampholder Features

- Citizen Electronics package using Nichia LEDs provide outstanding reliability, performance and color quality/consistency
- Unique 12-volt AC operation allows long runs up to 65 feet
- 0.5-watt, 1.0-watt and 1.5-watt models produce up to 398 lumens per foot utilizing 1/8 the power as compared to Xenon lamps
- Efficacies up to 57 lumens per watt
- 2700K, 3000K, 3500K and 4000K color temperatures
- 70% of initial illumination at end of 50,000 hour rated life... LEDs will not burn out
- Cool to touch operation with no UV or forward projected heat
- Dimmable with a wide variety of commonly available low voltage dimmers*
- Color-neutral, natural finish standard – no finish to specify

Trac 12 Xenon/Halogen Lampholder Features

- Low initial cost, low lamp replacement cost
- Up to 20,000 hour rated lamp life
- Dimmable using standard low voltage wall box dimmers
- Warm 2800K-3000K incandescent color temperature which warms further when dimmed

* See specification sheet or call Juno Technical Services for current list of approved dimmers for this application.



Listings UL/C-UL

Linear Lighting



LED Lampholders



Height: 7/16"

TL214LEDX1-27K
0.5 Watts/2700K
TL214LEDX1-3K
0.5 Watts/3000K
TL214LEDX1-35K
0.5 Watts/3500K
TL214LEDX1-4K
0.5 Watts/4000K



Height: 7/16"

TL214LEDX2-27K
1.0 Watts/2700K
TL214LEDX2-3K
1.0 Watts/3000K
TL214LEDX2-35K
1.0 Watts/3500K
TL214LEDX2-4K
1.0 Watts/4000K



Height: 7/16"

TL214LEDX3-27K
1.5 Watts/2700K
TL214LEDX3-3K
1.5 Watts/3000K
TL214LEDX3-35K
1.5 Watts/3500K
TL214LEDX3-4K
1.5 Watts/4000K



Height: 1-5/8"

TL103LED-3K
4.4 Watts/3000K
TL103LED-4K
4.4 Watts/4100K
WH-White, BL-Black,
SL-Silver

Incandescent Lampholders



Height: 1-5/8"

TL201 – (Single Lamp)
TL202 – (Double Lamp)
Wedge Base Xenon Lampholder
With polished aluminum reflector.
WH-White, BL-Black

Lamps
(Xenon T3-1/4 Wedge Base)
TL900 – 3W, 12V
TL901 – 5W, 12V
TL903 – 10W, 12V
TL905-24V – 5W, 24V*
TL910-24V – 10W, 24V*
*Frosted



Height: 3/4"

TL211 – Rigid Loop
Xenon Lampholder
With polished aluminum reflector.
WH-White, BL-Black

Lamps
(Xenon T3 Rigid Loop)
TL950CL – 5W, 12V
TL950FR – 5W, 12V
TL951CL – 10W, 12V
TL951FR – 10W, 12V
TL952CL-24V – 5W, 24V
TL952FR-24V – 5W, 24V
TL953CL-24V – 10W, 24V
TL953FR-24V – 10W, 24V
CL-Clear, FR-Frosted



Height: 1-1/4"

TL103 – Halogen Flood
WH-White, BL-Black
Lamps
(Halogen T3 Bi-Pin Capsule)
TL922 – 10W, 12V
TL923 – 20W, 12V
TL924-24V – 20W, 24V

Trac Sections



Height: 3/8"

Trac 12 – Each trac section contains two solid copper 12 AWG conductors and is supplied with an end feed connector, dead end, and mounting hardware.

TL2 – 2' Trac Section, 20-5/8" L. WH-White, BL-Black
TL4 – 4' Trac Section, 44-5/8" L. WH-White, BL-Black
TL6 – 6' Trac Section, 68-5/8" L. WH-White, BL-Black
TL8 – 8' Trac Section, 92-5/8" L. WH-White, BL-Black

Electrical Feeds & Joiners



TL34 – Conduit Feed
For surface wiring or top feed using 1/2" electrical connectors.
WH-White, BL-Black



TL24 – Right Angle Joiner
Joins two trac sections to form a 90° corner. WH-White, BL-Black



TL20 – Adjustable Joiner
Electrically joins two trac sections at variable angles.
WH-White, BL-Black



TL38 – End Feed Connector/
Dead End
For use with field cut-off trac sections. WH-White, BL-Black

Transformers



Remote Magnetic Transformers
Resettable circuit breaker and dual tap primary to adjust for voltage drop. Vertical mount only.

12-Volt Transformers (LED Compatible)
TL575-20-BL – 20VA circuit for 0.5-20 watts for incandescent or LED loads.
TL575-40-BL – 40VA circuit for 0.5-40 watts for incandescent or LED loads.
TL575-75-BL – 75VA circuit for 0.5-75 watts for incandescent or LED loads.
10-3/4" L x 4-3/8" W x 4-1/8" D.
BL-Black
TL554N-BL – (1) 150VA circuit for 50-150 watts for incandescent loads, 75-150 watts for LED loads.
10-3/4" L x 4-3/8" W x 4-1/8" D.
BL-Black
TL549N-BL – (1) 240VA circuit for 120-240 watts for incandescent or LED loads.
10-3/4" L x 4-3/8" W x 4-1/8" D.
BL-Black

12-Volt Transformers (LED Compatible)
TL550N-BL – (2) 240VA circuits, each for 120-240 watts for incandescent or LED loads.
11-3/8" L x 5-3/8" W x 5-1/8" D.
BL-Black

Transformers (cont'd)



Remote Magnetic Transformers 24-Volt Transformers (Incandescent Only)
TL553N-BL-24V – (1) 250VA circuit for 100 to 250 watts.
10-3/4" L x 4-3/8" W x 4-1/8" D.
BL-Black
TL551N-BL-24V – (1) 480VA circuit for 240 to 480 watts.
11-1/2" L x 5-3/8" W x 5-1/8" D.
BL-Black
TL552N-BL-24V – (2) 480VA circuits, each for 240 to 480 watts.
12-1/2" L x 6-1/8" W x 5-7/8" D.
BL-Black



Electronic Transformers TL547 – 150VA Surface Transformer (Incandescent Only)
Low-profile electronic 12-volt transformer with on/off switch for trac runs between 50 and 150 watts. Can be installed in-line with trac or remote up to 5' from trac. 120V supply can be fed into end or top using standard 1/2" electrical connectors.
Dimensions: 1-5/8" H x 2-1/2" W x 7" L.
WH-White, BL-Black



TL548 – 60VA Plug-In Transformer (Incandescent Only)



TL548U – 60VA Plug-In Transformer (LED-Compatible)
Economy plug-in 12-volt transformer for trac runs up to 60 watts. Supplied with 10' of 2-wire cord and on/off line cord switch.
3-1/8" H x 1-1/2" W x 1-3/8" D.
WH-White, BL-Black



TL601E Electronic Driver/Transformers (LED-Compatible)
TL601E-10
12V output for 0.5 to 10 Watts.
TL601E-25
12V output for 0.5 to 25 Watts.
TL601E-60
12V output for 0.5 to 60 Watts.
TL601E-75
12V output for 0.5 to 75 Watts.
1" H x 1-1/2" W x 5-1/2" L
WH-White, BL-Black



TL602E Class 2 Electronic Driver/Transformers (LED-Compatible)
TL602E-10
12V output for 0.5 to 10 Watts.
TL602E-25
12V output for 0.5 to 25 Watts.
TL602E-60
12V output for 0.5 to 60 Watts.
1" H x 1-1/2" W x 5-1/2" L
WH-White

For complete system information, see the Trac 12 brochure on www.junolightinggroup.com

Note: Use only LED compatible drivers and transformers with LED lampholders. Transformers shown are 120V AC input. Consult website or Trac 12 brochure for 277V versions.

Listings UL/C-UL

Application Guide

Task Lighting

Juno undercabinet luminaires place bright lighting onto the work surface from a source that is located in close proximity to the task being performed. This placement is optimal, as general lighting is often blocked by a body shadow or a shadow from upper cabinets. In addition, undercabinet lighting provides the increased light levels required to accurately, quickly, and safely perform tasks.

Recommended Illuminance Levels 20–50 footcandles is generally perceived as adequate to perform kitchen undercabinet tasks such as food preparation or paying bills. More detailed tasks such as sewing or craftwork require 50–100 footcandles. Tasks that are very small, have intricate detail, or involve very dark surfaces may require even higher illumination levels.

Accent Lighting

Cabinets and shelves create dark cavities that can detract from the aesthetics of a room. Juno undercabinet fixtures illuminate these cavities, to create visual interest and a sense of spaciousness, and/or to highlight objects of interest.

Recommended Illuminance Levels Accent lighting usually requires 20 footcandles or less.

Cove Lighting

Indirectly lighting over cabinets or in architectural coves can increase the sense of spaciousness and add drama and pleasing warmth to an interior.

Recommended Illuminance Levels Cove lighting usually requires 20 footcandles or less.

Special Design Considerations

Dark Interior Finishes The amount of perceived light from undercabinet, accent, and cove lighting will vary greatly depending on the reflectance value of surrounding surfaces. A dark countertop and backsplash will absorb light from undercabinet fixtures and diminish the appearance of the counter being illuminated. Likewise, indirectly illuminating a dark wood paneled ceiling from an architectural cove will be much less dramatic than illuminating a white ceiling. Allowing for increased levels of illumination can partially offset light absorption of dark surfaces.

High Ambient Light Levels The apparent brightness of a lighted countertop, cabinet interior, or cove will also vary depending on the amount of general room illumination. If the general ambient lighting is 30 footcandles, then a cabinet interior illuminated to only 20 footcandles will not appear illuminated. Conversely, in a darkened room, 20 footcandles will appear brilliant. A minimum 3:1 ratio between the focus area and background is recommended to have visual impact.

Age As age increases, so does our need for light. A typical 65-year-old needs 10 to 15 times more light than a teenager to experience equal visual acuity.

Shiny Work Surfaces For high-gloss countertops and backsplashes, place the fixture at the front edge of the cabinet to minimize glare reflecting back into the eyes of someone working at the counter. Keep in mind that shiny dark surfaces act like a mirror, and will reflect any source of light that is placed above them. How the reflected image of one fixture appears vs. another is subjective.

Selecting the Best Type of Lamp for Your Application

LED Light Emitting Diodes exhibit many of the characteristics of point source halogen and xenon lamps, yet, like fluorescents, operate using a fraction of the electricity with much less heat generation. At the end of their exceptionally long 50,000 hour rated life, LEDs maintain 70% of their initial output and never really burn out...they simply will produce less light as they age. Solo-Task, Trac 12, Pro-Series, and Danalite LED fixtures are dimmable, but unlike halogen or xenon lamps which take on a characteristic warm tone when dimmed, they maintain a constant color temperature throughout their dimming range. Cooler 4100K and 5000K LEDs produce more illumination than equivalent wattage 2700K or 3000K LEDs, as the cooler phosphors employed in LEDs are inherently more efficient.

Fluorescent The diffuse quality of fluorescent lamps, as used in the Fluorescent series, make them ideal for providing shadow-free task illumination in kitchens, home offices, and other work areas. Long life, very low energy consumption, and cool operating temperatures are important considerations for applications with long burning hours. The Fluorescent series uses the latest generation of high efficiency, high color rendering T5 lamps which approximates the color of halogen and has a 10,000 hour rated life.

Halogen and Xenon The specular “point-source” nature of both halogen and xenon lamps creates sparkle and highlights texture, color, and 3-dimensional definition of displayed objects. These lamps are excellent choices for task and accent lighting. In addition, they may be dimmed to create a warmer appearance and/or lower-level mood or night lighting.

- 12-volt halogen lamps, as used in the Pro-Series Halogen series, produce the whitest and brightest illumination with best color rendering using less energy and producing less heat.
- 120-volt halogen lamps, as used in the Line Voltage Halogen series, produce a warmer tone than low voltage halogen, and offer lower initial fixtures cost, as they do not require a step-down transformer to operate.
- 12-volt xenon lamps, as used in both Xenon series, produce a slightly warmer light than low voltage halogen. They also have a long 10,000-hour lamp life.
- 12- or 24-volt xenon lamps, as used in Trac 12, have a slightly warmer color temperature than halogen, and offer the most flexibility to achieve custom lighting effects such as undershelf, internal cabinet, indirect cove lighting and kick spaces. They also have a long, up to 20,000-hour life when operated at the recommended 11.5 volts.

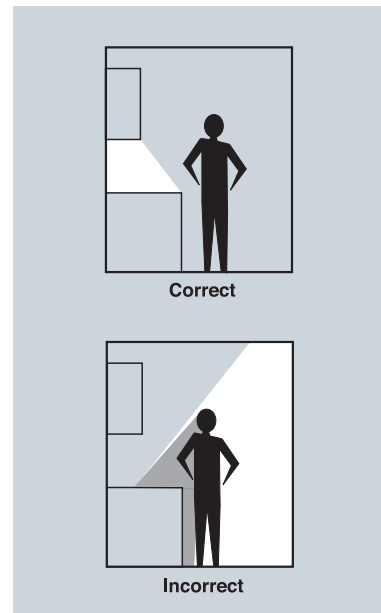

Application Guide



Footcandles on Horizontal Work Surface

Fixture	Cat #	Lamp	Beam Width*	Footcandles***			
				A	B	C	D
Solo-Task LED	USTL1/USTLR1	(3) 4-watt LEDs	51"	29	77	42	30
	USTL1/USTLR1	(3) 4-watt LEDs	53"	29	61	41	30
	USTL1/USTLR1	(3) 4-watt LEDs	56"	26	42	34	27
Pro-Series LED	UPLED09	(2) 1-watt LED	20"	12	37	17	13
	UPLED14	(4) 1-watt LEDs	22"	22	64	31	24
	UPLED22	(6) 1-watt LEDs	28"	30	86	41	31
	UPLED30	(8) 1-watt LEDs	32"	35	97	50	38
Pro-Series Halogen	ULH109	(1) 20-watt Halogen	21"	8	29	26	34
	ULH214	(2) 20-watt Halogen	23"	14	52	46	52
	ULH322	(3) 20-watt Halogen	31"	23	72	63	59
	ULH430	(4) 20-watt Halogen	36"	23	74	69	61
Pro-Series Xenon	UPX109	(1) 20-watt High-Output Xenon	21"	9	31	28	35
	UPX214	(2) 20-watt High-Output Xenon	23"	15	53	48	54
	UPX322	(3) 20-watt High-Output Xenon	31"	24	72	65	62
	UPX430	(4) 20-watt High-Output Xenon	36"	23	75	69	64
Pro-Series Fluorescent	UPF12	8-watt T5 Fluorescent	21"	22	64	34	39
	UPF22	14-watt T5 HE Fluorescent	27"	37	105	59	65
	UPF34	21-watt T5 HE Fluorescent	34"	47	126	75	73
	UPF46	28-watt T5 HE Fluorescent	43"	61	162	100	96
Economy Fluorescent	UFL12	8-watt T5 Fluorescent	24"	32	77	68	93
	UFL22	14-watt T5 HE Fluorescent	31"	64	135	130	157
	UFL34	21-watt T5 HE Fluorescent	41"	66	140	131	140
	UFL46	28-watt T5 HE Fluorescent	50"	83	171	166	170
Economy Xenon	ULX109	(1) 18-watt Xenon	21"	14	25	20	25
	ULX212	(2) 18-watt Xenon	24"	30	52	42	49
	ULX318	(3) 18-watt Xenon	28"	40	72	55	59
	ULX424	(4) 18-watt Xenon	32"	44	75	64	61
Economy Line Voltage Halogen	UH106	(1) 25-watt Halogen	12"	8	33	19	18
	UH212	(2) 25-watt Halogen	22"	12	60	35	35
	UH318	(3) 25-watt Halogen	28"	19	93	51	48
DanaLite LED	DL112-3-C	(4) 3000K 1-watt LEDs	**	15	36	22	23
	DL112-4-C	(4) 4100K 1-watt LEDs	**	20	48	30	32
	DL112-5-C	(4) 5000K 1-watt LEDs	**	24	56	36	39
	DL112-3H-C	(4) High CRI, 3000K 1W LEDs	**	13	31	19	20
Trac 12 Xenon and Halogen	TL201	5-watt Xenon, 3" On Center	**	10	31	20	22
	TL202	10-watt Xenon, 12" On Center	**	12	36	23	25
	TL211	10-watt Xenon, 6" On Center	**	14	43	28	30
	TL103	20-watt Halogen, 12" On Center	**	16	66	56	60
Trac 12 LED	TL214LEDX1-27K	0.5-watt 27K LED, 3" On Center	**	17	45	27	22
	TL214LEDX1-3K	0.5-watt 3K LED, 3" On Center	**	17	46	27	22
	TL214LEDX1-35K	0.5-watt 35K LED, 3" On Center	**	18	48	28	23
	TL214LEDX1-4K	0.5-watt 4K LED, 3" On Center	**	19	50	30	24
	TL214LEDX2-27K	1.0-watt 27K LED, 3" On Center	**	34	90	52	43
	TL214LEDX2-3K	1.0-watt 3K LED, 3" On Center	**	34	91	54	44
	TL214LEDX2-35K	1.0-watt 35K LED, 3" On Center	**	34	91	54	44
	TL214LEDX2-4K	1.0-watt 4K LED, 3" On Center	**	38	99	58	47
	TL214LEDX3-27K	1.5-watt 27K LED, 3" On Center	**	49	127	73	59
	TL214LEDX3-3K	1.5-watt 3K LED, 3" On Center	**	50	134	78	63
	TL214LEDX3-35K	1.5-watt 35K LED, 3" On Center	**	53	139	82	66
	TL214LEDX3-4K	1.5-watt 4K LED, 3" On Center	**	55	147	86	69

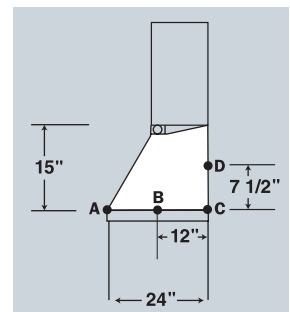
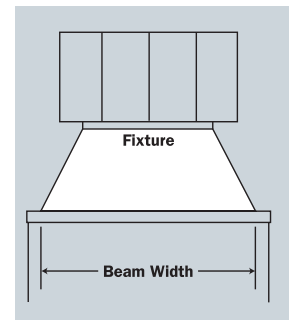

* Beam width defined as 50% of maximum footcandles.
 ** Assumes continuous lighting, so beam width is same as counter width. Rear wall reflectance 50%. Counter surface reflectance 20%.
 *** Except for Solo-Task LED, Trac 12 Xenon and Halogen and Trac 12 LED, all data is for a single fixture.

Cabinetry Lighting Guidelines

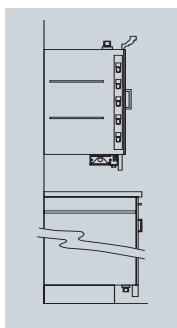

Over Cabinets Trac 12, using 10-watt Xenon, or 1.0-watt LED lamps spaced 6" on center, generally provides excellent indirect lighting. For lower-level mood lighting, use 3 to 5-watt Xenon, or 0.5-watt LED lamps with slightly closer spacing. Juno Fluorescent and LED fixtures may also be used where energy efficiency is a primary consideration, or higher light levels are required. Placing the fixture at the front edge of the cabinet top will project light into the space and illuminate any displayed objects.

Inside Cabinets Running Trac 12 vertically on the front inside of cabinets avoids the need to put trac on each shelf. 3-watt Xenon spaced 3" on center or 0.5 watt LED lamps spaced 4" to 6" on center will generally provide adequate lighting inside a cabinet.

Under Cabinets Placing Juno undercabinet fixtures at the front lip of the cabinet conceals the fixture from view, minimizes veiling reflections, and provides maximum light on the working area of the countertop.

Kick Spaces Trac 12, using 3-watt Xenon or 0.5-watt LED lamps spaced on 4" center, provides adequate kick space lighting. Wider spacings can be used when the distance from trac to floor is greater than 4" or when even illumination is not required.

Note: Shiny flooring may cause objectionable lamp image reflections.





DanaLite LED

DL100-3C-S	17
DL100-3F-S	17
DL100-3HC-S	17
DL100-3HF-S	17
DL100-4C-S	17
DL100-4F-S	17
DL100-5C-S	17
DL100-5F-S	17
DL101-E	17
DL101-P	17
DL102-EE	17
DL102-FLX2	17
DL102-FLX37	17
DL103-AME48-S	17
DL103-AME96-S	17
DL103-MS48-S	17
DL103-MS96-S	17
DLD-100	17
DLD-17-120	17
DLD-25	17
DLD-80-120	17

Economy Fluorescent

UFL12	10
UFL22	10
UFL34	10
UFL46	10
ULH-CONN	10
ULH-CP	10

Economy Line Voltage Halogen

DWM1-WH	12
JC2-8-WH	12
JC2-17-WH	12
JC2-26-WH	12
T925	12
UH106-WH	12
UH212-WH	12
UH318-WH	12

Economy Xenon

ULH-CONN	11
ULH-CP	11
ULX109-WH	11
ULX212-WH	11
ULX318-WH	11
ULX424-WH	11

Pro-Series Fluorescent

JC3-8	9
JC3-17	9
JC3-26	9
ULH-CONN	9
ULH-CP	9
ULH-DWM	9
UPF12	9
UPF22	9
UPF34	9
UPF46	9

Pro-Series Halogen

JC3-8	7
JC3-17	7
JC3-26	7
ULH109	7
ULH214	7
ULH322	7
ULH430	7
ULH-CONN	7
ULH-CP	7
ULH-DWM	7

Pro-Series LED

JC3-8	6
JC3-17	6
JC3-26	6
ULH-CONN	6
ULH-CP	6
ULH-DWM	6
UPLD09	6
UPLD14	6
UPLD22	6
UPLD30	6

Pro-Series Xenon

UPX109	8
UPX214	8
UPX322	8
UPX430	8
JC3-8	8
JC3-17	8
JC3-26	8
ULH-CONN	8
ULH-CP	8
ULH-DWM	8
UPX-LAMP	8

Solo-Task LED

CP6	15
TL548U	15
TL576-10-BL	15
TL576-25-BL	15
TL576-60-BL	15
UK3STL-3K	15
UST18G-10	15
UST18G-25	15
USTL1-3K	15
USTLR1-3K	15
USTL-REC	15

Trac 12

Lampholders & Lamps

TL103	19
TL103LED-3K	19
TL103LED-4K	19
TL201	19
TL202	19
TL211	19
TL214LEDX1-27K	19
TL214LEDX1-3K	19
TL214LEDX1-35K	19
TL214LEDX1-4K	19
TL214LEDX2-27K	19
TL214LEDX2-3K	19
TL214LEDX2-35K	19
TL214LEDX2-4K	19
TL214LEDX3-27K	19
TL214LEDX3-3K	19
TL214LEDX3-35K	19
TL214LEDX3-4K	19
TL900	19
TL901	19
TL903	19
TL905-24V	19
TL910-24V	19
TL922	19
TL923	19
TL924-24V	19
TL950CL	19
TL950FR	19
TL951CL	19
TL951FR	19
TL952CL-24V	19
TL952FR-24V	19
TL953CL-24V	19
TL953FR-24V	19

Trac

TL2	19
TL4	19
TL6	19
TL8	19

Electrical Feeds & Joiners

TL20	19
TL24	19
TL34	19
TL38	19

Transformers

TL547	19
TL548	19
TL548U	15, 19
TL549N-BL	19
TL550N-BL	19
TL551N-BL-24V	19
TL552N-BL-24V	19
TL553N-BL-24V	19
TL554N-BL	19
TL575-20	19
TL575-40	19
TL575-75	19
TL576-10	15
TL576-25	15
TL576-60	15
TL601E-10	19
TL601E-25	19
TL601E-60	19
TL601E-75	19
TL602E-10	15, 19
TL602E-25	15, 19
TL602E-60	15, 19



Juno

Recessed and Trac Lighting

indy

Architectural Recessed Lighting

AccuLite

Commercial and Industrial Lighting

AcuLux

Precision Recessed Lighting

Navilite

Exit and Emergency Lighting

DanaLite

Architectural Linear Lighting

Additional undercabinet and linear lighting solutions literature



Juno Undercabinet Solo-Task LED Lighting



Juno Trac 12 Miniaturized Low-Voltage Trac System



DanaLite Architectural Linear Lighting

1300 S. Wolf Road • Des Plaines, IL 60018
 PHONE 847.827.9880 • www.junolightinggroup.com

Regional Offices & Warehouses:
 California, Illinois, Indiana, Pennsylvania, Texas, Ontario CN



Products shown in this brochure are covered by U.S. and international patents and patents pending

Specifications subject to change without notice.
 © 2012 JUNO LIGHTING, LLC.

Printed in the U.S.A. LIT-UC Rev. 2 1/13