

USER'S MANUAL
SMOKE & CARBON MONOXIDE ALARM

AC Powered Smoke & Carbon Monoxide Alarm

Features:

- Voice with Programmable Location
- Two Latching Features
- Smart Interconnect
- Optipath 360 Technology™
- Two Silence Features
- Alkaline Battery Backup

Exclusive Voice Warning!
With Location!

LISTED TO UL 217 and UL 2034 STANDARDS
Model SC7010BV

Printed in Mexico
M08-0183-006 K1 09/10



IMPORTANT! PLEASE READ CAREFULLY AND SAVE.
This user's manual contains important information about your Alarm's operation. If you are installing the Alarm for use by others, you must leave this manual—or a copy of it—with the end user.

INTRODUCTION

Thank you for choosing First Alert® for your Smoke and Carbon Monoxide Alarm needs. You have purchased a state-of-the-art Smoke & Carbon Monoxide Alarm designed to provide you with early warning of a fire or Carbon Monoxide. **Key features include:**

Smoke & Carbon Monoxide Combination Alarm. One alarm protects against two deadly household threats.

Exclusive Voice Warning with Location will tell you the preprogrammed location of the initiating unit and danger detected. Programmable up to 11 locations (ex. "basement"). When alarms sounds, if programmed for basement it will say "Warning, evacuate, smoke in basement".

Spread Spectrum Horn Tone. Lower and varying horn frequency makes it easier for elderly with normal age related hearing loss to hear horn. Sweeps through the 2200 – 3400 Hz range.

Smart Interconnect can be interconnected to BRK Smoke, CO, and Heat Alarms. One interconnect wire carries both smoke and CO alarm signals.

Optipath 360 Technology™ provides 360 degrees of direct access to the smoke sensor.

Single Button Test/Silence eliminates confusion. Depending on what mode the alarm is in, pushing the button provides different functions such as testing the alarm, silencing the alarm, re-testing the alarm when in silence and clearing the Latching features.

Two Silence Features. Temporarily silence low battery chirp for up to eight hours before replacing low battery or silence an unwanted alarm for several minutes.

Two Latching Features. Alarm Latch: Easily identifies initiating alarm even after alarm condition has subsided. Low Battery Latch: Identifies which unit is in low battery condition.

Perfect Mount System includes a gasketless base for easy installation and a mounting bracket that keeps the alarm secure over a wide rotation range to allow for perfect alignment.

Dust Cover is included to keep the alarm clean during construction.

Easy Installation/Maintenance features include a large opening in the mounting bracket for easy access to wiring. A battery pull tab that keeps the battery fresh until the home is occupied. A Side Load Battery Drawer allows for easy battery replacement without removing the alarm from the ceiling or wall.

End of Life Signal. Provides audible confirmation alarm needs to be replaced.

Improved UV Resistance keeps the alarm from discoloring over time.

© 2010 BRK Brands, Inc. All rights reserved.
Distributed by BRK Brands, Inc.
3901 Liberty Street Road, Aurora, IL 60504-8122
Consumer Affairs: (800) 323-9005 • www.firstalert.com

All First Alert® Smoke Alarms conform to regulatory requirements, including UL217 and are designed to detect particles of combustion. Smoke particles of varying number and size are produced in all fires.

Ionization technology is generally more sensitive than photoelectric technology at detecting small particles, which tend to be produced in greater amounts by flaming fires, which consume combustible materials rapidly and spread quickly. Sources of these fires may include paper burning in a wastebasket, or a grease fire in the kitchen.

Photoelectric technology is generally more sensitive than ionization technology at detecting large particles, which tend to be produced in greater amounts by smoldering fires, which may smolder for hours before bursting into flame. Sources of these fires may include cigarettes burning in couches or bedding.

For maximum protection, use both types of Smoke Alarms on each level and in every bedroom of your home.

⚠ DANGER!
ELECTRICAL SHOCK HAZARD. Turn off the power to the area where the Smoke Alarm is installed before removing it from the mounting bracket. Failure to turn off the power first may result in serious electrical shock, injury or death.

⚠ WARNING!

- This unit will not alert hearing impaired residents. It is recommended that you install special units which use devices like flashing strobe lights to alert hearing impaired residents.
- Installation of this unit must conform to the electrical codes in your area; Articles 210 and 300.3 (B) of NFPA 70 (NEC), NFPA 72, NFPA 101; SBC (SBCCI); UBC (ICBO); NBC (BOCA); OTFDC (CABO), and any other local or building codes that may apply. Wiring and installation must be performed by a licensed electrician. Failure to follow these guidelines may result in injury or property damage.
- This unit must be powered by a 24-hour, 120VAC pure sine wave 60Hz circuit. Be sure the circuit cannot be turned off by a switch, dimmer, or ground fault circuit interrupter. Failure to connect this unit to a 24-hour circuit may prevent it from providing constant protection.
- This Alarm must have AC or battery power to operate. If the AC power fails, battery back-up will allow the alarm to sound for at least 4 minutes. If AC power fails and the battery is weak, protection should last for at least 7 days. If AC power fails and the battery is dead or missing, the alarm cannot operate.
- Never disconnect the power from an AC powered unit to stop an unwanted alarm. Doing so will disable the unit and remove your protection. In the case of a true unwanted alarm open a window or fan the smoke away from the unit. The alarm will reset automatically when it returns to normal operation. Never remove the batteries from a battery operated unit to stop an unwanted alarm (caused by cooking smoke, etc.). Instead open a window or fan the smoke away from the unit. The alarm will reset automatically.

⚠ CAUTION!

- Connect this unit ONLY to other compatible units. See "How To Install This Smoke Alarm" for details. Do not connect it to any other type of alarm or auxiliary device. Connecting anything else to this unit may damage it or prevent it from operating properly.
- This Smoke/CO Alarm has a battery drawer which resists closing unless a battery is installed. This warns you the unit will not operate under DC power without a battery.
- Do not stand too close to the unit when the alarm is sounding. It is loud to wake you in an emergency. Exposure to the horn at close range may harm your hearing.
- Do not paint over the unit. Paint may clog the openings to the sensing chambers and prevent the unit from operating properly.

INSTALLATION

WHERE TO INSTALL THIS ALARM

Minimum coverage for Smoke Alarms, as recommended by the National Fire Protection Association (NFPA), is one Smoke Alarm on every floor, in every sleeping area, and in every bedroom (See "Regulatory Information For Smoke Alarms" for details on the NFPA recommendations).

For **CO Alarms,** the National Fire Protection Association (NFPA) recommends that a CO Alarm should be centrally located outside of each separate sleeping area in the immediate vicinity of the bedrooms. For added protection, install additional CO Alarms in each separate bedroom, and on every level of your home.

NOTE: For added protection, install an additional Smoke/CO Alarm at least 15 feet (4.6 meters) away from the furnace or fuel burning heat source where possible. In smaller homes or in manufactured homes where this distance cannot be maintained, install the Alarm as far away as possible from the furnace or other fuel burning source. Installing the Alarm closer than 15 feet (4.6 meters) will not harm the Alarm, but may increase the frequency of unwanted alarms.

In general, install combination Smoke and Carbon Monoxide Alarms:

- On every level of your home, including finished attics and basements.
- Inside every bedroom, especially if people sleep with the door partly or completely closed.
- In the hall near every sleeping area. If your home has multiple sleeping areas, install a unit in each. If a hall is more than 40 feet (12 meters) long, install a unit at each end.
- At the top of first-to-second floor stairs.
- At the bottom of the basement stairs.
- For additional coverage, install Alarms in all rooms, halls, and storage areas, where temperatures normally remain between 40° F and 100° F (4° C and 38° C).

RECOMMENDED PLACEMENT

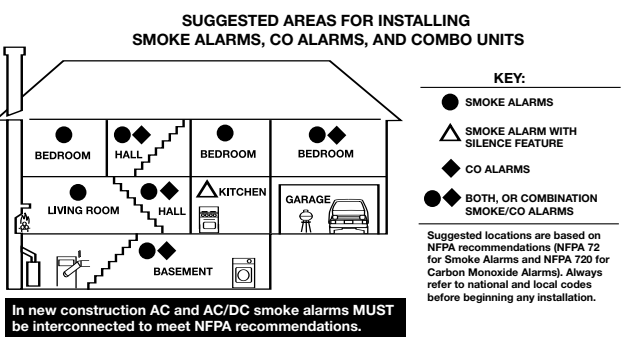

- When installing on the wall, the top edge of Smoke Alarms should be placed between 4 inches (102 mm) and 12 inches (305 mm) from the wall/ceiling line.
- When installing on the ceiling, place the alarm as close to the center as possible.
- In either case, install at least 4 inches (102 mm) from where the wall and ceiling meet. See "Avoiding Dead Air Spaces" for more information.

NOTE: For any location, make sure no door or other obstruction could keep carbon monoxide or smoke from reaching the Alarm.

Installing Smoke/CO Alarms in Mobile Homes
For minimum security install one Smoke/CO Alarm as close to each sleeping area as possible. For more security, put one unit in each room. Many older mobile homes (especially those built before 1978) have little or no insulation. If your mobile home is not well insulated, or if you are unsure of the amount of insulation, it is important to install units on inside walls only.

WHERE THIS ALARM SHOULD NOT BE INSTALLED

DO NOT locate this Smoke/CO Alarm:

- In garages, furnace rooms, crawl spaces and unfinished attics. Avoid extremely dusty, dirty or greasy areas.
- Where combustion particles are produced. Combustion particles form when something burns. Areas to avoid include poorly ventilated kitchens, garages, and furnace rooms. Keep units at least 20 feet (6 meters) from the sources of combustion particles (stove, furnace, water heater, space heater) if possible. In areas where a 20-foot (6 meter) distance is not possible – in modular, mobile, or smaller homes, for example – it is recommended the Smoke Alarm be placed as far from these fuel-burning sources as possible. The placement recommendations are intended to keep these Alarms at a reasonable distance from a fuel-burning source, and thus reduce "unwanted" alarms. Unwanted alarms can occur if a Smoke Alarm is placed directly next to a fuel-burning source. Ventilate these areas as much as possible.
- Within 5 feet (1.5 meters) of any cooking appliance. In air streams near kitchens. Air currents can draw cooking smoke into the smoke sensor and cause unwanted alarms.
- In extremely humid areas. This Alarm should be at least 10 feet (3 meters) from a shower, sauna, humidifier, vaporizer, dishwasher, laundry room, utility room, or other source of high humidity.
- In direct sunlight.
- In turbulent air, like near ceiling fans or open windows. Blowing air may prevent CO or smoke from reaching the sensors.
- In areas where temperature is colder than 40° F (4° C) or hotter than 100° F (38° C). These areas include non-air-conditioned crawl spaces, unfinished attics, uninsulated or poorly insulated ceilings, porches, and garages.
- In insect infested areas. Insects can clog the openings to the sensing chamber.
- Less than 12 inches (305 mm) away from fluorescent lights. Electrical "noise" can interfere with the sensor.
- In "dead air" spaces. See "Avoiding Dead Air Spaces".

AVOIDING DEAD AIR SPACES

"Dead air" spaces may prevent smoke from reaching the Smoke/CO Alarm. To avoid dead air spaces, follow installation recommendations below.

On ceilings, install Smoke/CO Alarms as close to the center of the ceiling as possible. If this is not possible, install the Smoke/CO Alarm at least 4 inches (102 mm) from the wall or corner.

For wall mounting (if allowed by building codes), the top edge of Smoke/CO Alarms should be placed between 4 inches (102 mm) and 12 inches (305 mm) from the wall/ceiling line, below typical "dead air" spaces.

On a peaked, gabled, or cathedral ceiling, install first Smoke/CO Alarm within 3 feet (0.9 meters) of the peak on the ceiling, measured horizontally. Additional Smoke/CO Alarms may be required depending on the length, angle, etc. of the ceiling's slope. Refer to NFPA 72 for details on requirements for sloped or peaked ceilings.

HOW TO INSTALL THIS SMOKE/CO ALARM

This Smoke/CO Alarm is designed to be mounted on any standard wiring junction box up to a 4-inch (10 cm) size, on either the ceiling or wall (if allowed by local codes). Read "Where to Install This Alarm" and "Where This Alarm Should Not Be Installed" before you begin installation. Tools you will need: • Needle-nose pliers or utility knife • Standard flathead screwdriver • Wire strippers.

⚠ WARNING!
Make sure the Alarm is not receiving excessively noisy power. Examples of noisy power could be major appliances on the same circuit, power from a generator or solar power, light dimmer on the same circuit or mounted near fluorescent lighting. Excessively noisy power may cause damage to your Alarm.

THE PARTS OF THIS ALARM

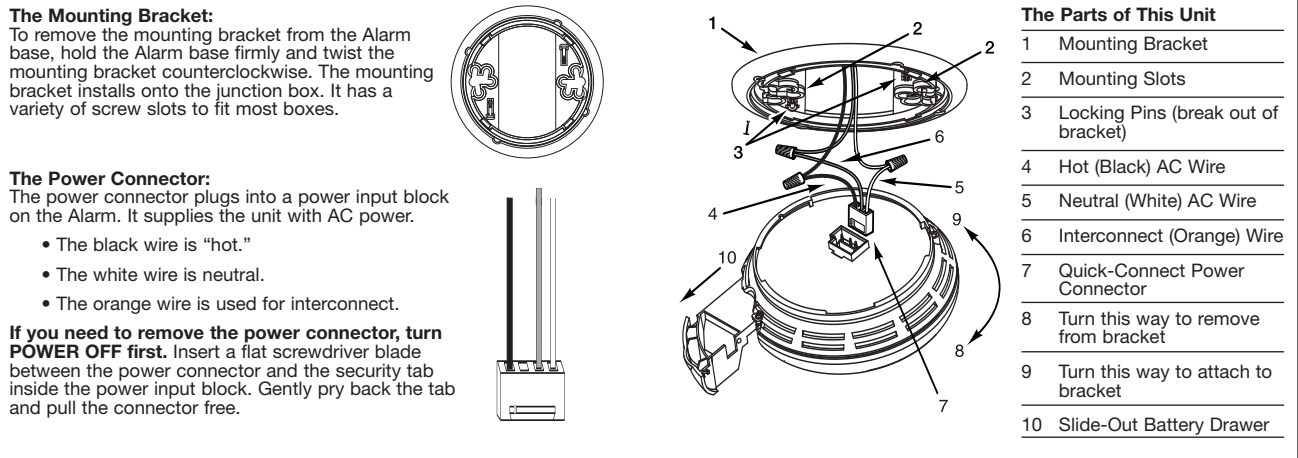

FOLLOW THESE INSTALLATION STEPS

The basic installation of this Alarm is similar whether you want to install one Alarm, or interconnect more than one Alarm. If you are interconnecting more than one Alarm, you MUST read "Special Requirements For Interconnected Alarms" below before you begin installation.

⚠ DANGER!
ELECTRICAL SHOCK HAZARD. Turn off power to the area where you will install this unit at the circuit breaker or fuse box before beginning installation. Failure to turn off the power before installation may result in serious electrical shock, injury or death.

- Remove the mounting bracket from the base, and attach it to the junction box.
- Using wire nuts, connect the power connector to the household wiring.

STAND-ALONE ALARM ONLY:

- Connect the white wire on the power connector to the neutral wire in the junction box.
- Connect the black wire on the power connector to the hot wire in the junction box.
- Tuck the orange wire inside the junction box. It is used for interconnect only.

INTERCONNECTED UNITS ONLY:

- Strip off about 1/2" (12 mm) of the plastic coating on the orange wire on the power connector.
- Connect the white wire on the power connector to the neutral wire in the junction box.
- Connect the black wire on the power connector to the hot wire in the junction box.
- Connect the orange wire on the power connector to the interconnect wire in the junction box. Repeat for each unit you are interconnecting. Never connect the hot or neutral wires in the junction box to the orange interconnect wire. Never cross hot and neutral wires between Alarms.

- Plug the power connector into the back of the Alarm.
- Activate the battery back-up by removing the "Pull to Activate Battery Back-Up" tab. Or, install battery back-up. Battery back-up cannot work until you install the battery in the correct position (Match "+" to "+" and "-" to "-").
- Position the base of the Alarm over the mounting bracket, and turn the Alarm clockwise (right) until the unit is in place. If wall mounted, adjust unit so words are level.
- Check all connections.

⚠ WARNING!
Improper wiring of the power connector or the wiring leading to the power connector will cause damage to the Alarm and may lead to a non-functioning Alarm.

STAND-ALONE ALARM ONLY:

- If you are only installing one Alarm, restore power to the junction box.

INTERCONNECTED UNITS ONLY:

- If you are interconnecting multiple Alarms, repeat steps 1-5 for each Alarm in the series. When you are finished, restore power to the junction box.

⚠ DANGER!

ELECTRICAL SHOCK HAZARD. Do not restore power until all Alarms are completely installed. Restoring power before installation is complete may result in serious electrical shock, injury or death.

- Make sure the Alarm is receiving AC power. Under normal operation, the Green power indicator light will shine continuously.
- If the Green power indicator light does not light, **TURN OFF POWER TO THE JUNCTION BOX** and recheck all connections. If all connections are correct and the Green power indicator still does not light when you restore the power, the unit should be replaced immediately.
- Test each Smoke Alarm. Press and hold the Test/Silence button until the unit alarms. When testing a series of interconnected units you must test each unit individually. Make sure all units alarm when each one is tested.

⚠ DANGER!
If any unit in the series does not alarm, **TURN OFF POWER** and recheck connections. If it does not alarm when you restore power, replace it immediately.

WEEKLY TESTING

⚠ WARNING!

- NEVER use an open flame of any kind to test this unit. You might accidentally damage or set fire to the unit or to your home. The built-in test switch accurately tests the unit's operation as required by Underwriters Laboratories, Inc. (UL). NEVER use vehicle exhaust! Exhaust may cause permanent damage and voids your warranty.
- If the Alarm ever fails to test properly, replace it immediately. Products under warranty may be returned to the manufacturer for replacement. See "Limited Warranty" at the end of this manual.

⚠ CAUTION!
It is important to test this unit every week to make sure it is working properly. Using the test button is the recommended way to test this Smoke/CO Alarm. You can test this Smoke/CO Alarm by pressing and holding the Test/Silence button on the Alarm cover until Alarm Voice says "Testing" (typically 3-5 seconds).

- During testing, you will see and hear the following sequence:
- The Alarm Voice will say "Testing." The Horn will sound 3 beeps, pause, 3 beeps. The Alarm Voice will say "Warning, evacuate smoke in [Location, example: "Basement"], Evacuate." The Power/Smoke LED flashes Red and the CO LED will be Off.
 - Next the Horn will sound 4 beeps, pause, 4 beeps. The Alarm Voice will say "Warning, evacuate carbon monoxide in [Location, example: "Basement"], Evacuate." The Power/Smoke LED will be Off and the CO LED flashes Red.

If the unit does not alarm, make sure the batteries are correctly installed, and test again. If the unit still does not alarm, replace it immediately.

STEP BY STEP GUIDE TO PROGRAMMING THIS ALARM

For First Time and When Changing Batteries

Action:	Alarm Will Say:
1. Insert batteries (2, AA batteries).	"Welcome, First Alert Carbon Monoxide and Smoke Alarm." "No location programmed" if first time or "[Location, example: "Basement"] location programmed" when changing batteries. "To select location, press and hold test button now."
2. Press & Hold Test Button if you would like to program the location or change the location of the Alarm. Release button after Alarm responds.	"To save location, press and hold test button after location is heard." Alarm will speak list of locations (see below).
3. After you hear the location of where you are placing the Alarm, Press & Hold the Test Button.	"[Location, example: "Basement"] location saved." If no location is chosen: "No location saved."

Your Alarm has now been programmed for the location of your choice. Available locations:

Basement	Kitchen	Child's Bedroom
Living Room	Dining Room	Master Bedroom
Family Room	No Location	Guest Bedroom
Office	Hallway	Utility Room

LOCKING FEATURES

The locking features are designed to discourage unauthorized removal of the batteries or Alarm. It is not necessary to activate the locks in single-family households where unauthorized battery or Alarm removal is not a concern. These Alarms have two separate locking features: one to lock the battery compartment, and the other to lock the Alarm to the mounting bracket. You can choose to use either feature independently, or use them both.

Tools you will need: • Needle-nose pliers • Standard Flathead screwdriver.

Both locking features use locking pins, which are molded into the mounting bracket. Using needle-nose pliers, remove one or both pins from the mounting bracket, depending on how many locking features you want to use.

IMPORTANT!
To permanently remove either lock, insert a flathead screwdriver between the locking pin and the lock, and pry the pin out of the lock.

TO LOCK THE BATTERY COMPARTMENT

Do not lock the battery compartment until you have installed the battery and tested the battery back-up.

- Push and hold Test/Silence button until the alarm sounds.

IMPORTANT!
If the unit does not alarm during testing, **DO NOT** lock the battery compartment! Install a new battery and test again. If the Alarm still does not alarm, replace it immediately.

- Using needle-nose pliers, detach one locking pin from the mounting bracket.

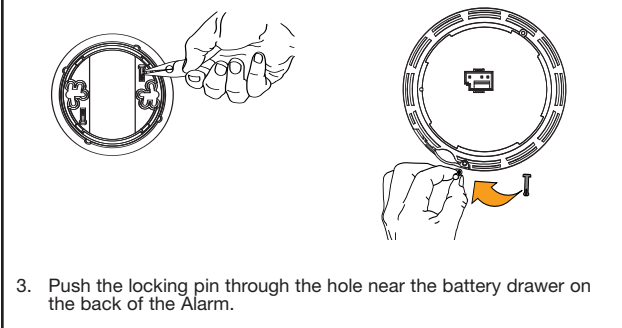

- Push the locking pin through the hole near the battery drawer on the back of the Alarm.

TO LOCK THE MOUNTING BRACKET

- Using needle-nose pliers, detach one locking pin from mounting bracket.

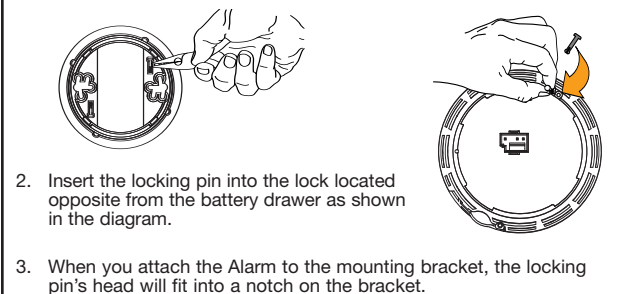

- When you attach the Alarm to the mounting bracket, the locking pin's head will fit into a notch on the bracket.

WHAT YOU WILL SEE AND HEAR WITH THIS ALARM

Under Normal Operations

Voice: Silent	Power/Smoke LED: Constant Green
Horn: Silent	CO LED: Off

When You Test the Alarm

Voice: "Testing." Horn: 3 beeps, pause, 3 beeps; Voice: "Warning, evacuate smoke in [Location, example: "Basement"], Evacuate."

CO LED: Flashes Red in sync with the horn pattern
CO LED: Off, followed by
Horn: 4 fast beeps, pause, 4 fast beeps;
Voice: "Warning, evacuate carbon monoxide in [Location, example: "Basement"], Evacuate." Pause. "Highest carbon monoxide level was [CO level example: 0 ppm]."
Power/Smoke LED: Off
CO LED: Flashes Red in sync with the horn pattern

If Battery Becomes Low or is Missing

Voice: "Replace battery in [Location, example "Basement"]," Repeated every 5 hours
Horn: chirps once a minute
Power/Smoke LED: Flashes Green On for 2 seconds/Off for 2 seconds. Low Battery Latch is now engaged.
CO LED: Off

If Alarm is Not Operating Properly (MALFUNCTION SIGNAL)

Voice: "Detector error in [Location, example "Basement"], please see manual." Repeated every 5 hours
Horn: 3 chirps every minute
Power/Smoke LED: 3 Flashes approximately once a minute
CO LED: Off

Alarm has reached its End of Life

Voice: "Detector error in [Location, example "Basement"], please see manual." Repeated every 5 hours
Horn: 5 chirps every minute
Power/Smoke LED: 5 Flashes approximately once a minute
CO LED: Off

Alarm Levels of CO are Detected

Horn: 4 fast beeps, pause, 4 fast beeps, pause*
Voice: "Warning, evacuate carbon monoxide in [Location, example: "Basement"], Evacuate." Pause. "Highest carbon monoxide level was [CO level example: ___ ppm]."
Horn: 4 beeps, pause, 4 beeps, pause repeating 2 times followed by Voice Warning above.
Power/Smoke LED: Off
CO LED: During Alarm: Flashes Red in sync with the horn pattern. After Alarm: Flashes Red On for 2 seconds/Off for 2 seconds. CO Alarm Latch is now engaged.

Smoke is Detected

Horn: 3 beeps, pause, repeating 8 times
Voice: "Warning, evacuate smoke in [Location, example: "Basement"], Evacuate."
Horn: 3 beeps, pause, repeating 3 times followed by Voice Warning above.
Power/Smoke LED: During Alarm: Flashes Red in sync with the horn pattern. After Alarm: Flashes Red On for 2 seconds/Off for 2 seconds. Smoke Alarm Latch is now engaged.

Smoke Alarm is Silenced Voice: "Horn silenced, Detector active." Horn: Off Power/Smoke LED: Flashes Red CO LED: Off	CO Alarm is Silenced Voice: "Horn silenced, Detector active." Horn: Off Power/Smoke LED: Off CO LED: Flashes Red
--	---

TO UNLOCK THE BATTERY COMPARTMENT

IMPORTANT!
Once the Alarm is installed, you must disconnect it from the AC power before unlocking the battery compartment.

⚠ DANGER!
ELECTRICAL SHOCK HAZARD. Turn off the power to the area where the Alarm is installed before removing it from the mounting bracket. Failure to turn off the power first may result in serious electrical shock, injury or death.

⚠ WARNING!
Always discharge the branch circuit before servicing an AC or AC/DC Alarm. First, turn off the AC power at the circuit breaker or fuse box. Next, remove the battery from Alarms with battery back-up. Finally, press and hold the Test/Silence button for 5-10 seconds to discharge the branch circuit.

- Remove the Alarm from the mounting bracket. If the unit is locked to the bracket, see the section "To Unlock the Mounting Bracket."
- Disconnect the power connector by gently prying it away from the back of the Alarm.
- Insert a flathead screwdriver under the head of the locking pin, and gently pry it out of the battery compartment lock. (If you plan to relock the battery compartment, save the locking pin.)
- To relock the battery compartment, close the battery door and reinsert locking pin in lock.
- Reconnect the power connector to the back of the Alarm, reattach the Smoke Alarm to the mounting bracket, and restore the power.

IMPORTANT!
When replacing the batteries, always test the Alarm before relocking the battery compartment.

TO UNLOCK THE MOUNTING BRACKET

⚠ DANGER!
ELECTRICAL SHOCK HAZARD. Turn off the power to the area where the Alarm is installed before removing it from the mounting bracket. Failure to turn off the power first may result in serious electrical shock, injury or death.

⚠ WARNING!
Always discharge the branch circuit before servicing an AC or AC/DC Alarm. First, turn off the AC power at the circuit breaker or fuse box. Next, remove the battery from Alarms with battery back-up. Finally, press and hold the Test/Silence button for 5-10 seconds to discharge the branch circuit.

- Insert a flathead screwdriver between the mounting bracket pin and the mounting bracket.
- Pry the Alarm away from the bracket by turning both the screwdriver and the Alarm counterclockwise (left) at the same time.

REGULAR MAINTENANCE

⚠ WARNING!
Use only the replacement batteries listed below. The unit may not operate properly with other batteries. Never use rechargeable batteries since they may not provide a constant charge.

This unit has been designed to be as maintenance-free as possible, but there are a few simple things you must do to keep it working properly:

- Test it at least once a week.
- Clean the Smoke/CO Alarm at least once a month; gently vacuum the outside of the Smoke/CO Alarm using your household vacuum's soft brush attachment. Test the Smoke/CO Alarm. Never use water, cleaners or solvents since they may damage the unit.
- If the Smoke/CO Alarm becomes contaminated by excessive dirt, dust and/or grime, and cannot be cleaned to avoid unwanted alarms, replace the unit immediately.
- Relocate the unit if it sounds frequent unwanted alarms. See "Where This Alarm Should Not Be Installed" for details.
- When the battery back-up becomes weak, the Alarm will "chirp" about once a minute (the low battery warning), and the Voice will say "Replace battery in [Location, example "Basement"]," Repeated every 5 hours. This warning should last 7 days, but you should replace the battery immediately to continue your protection. The Low Battery Latch feature will be engaged. The Green Power/Smoke LED will flash On for 2 seconds/Off for 2 seconds.

Choosing a replacement battery:
Your Smoke/CO Alarm requires two "AA" Energizer E91 batteries. These batteries are available at many local retail stores.

IMPORTANT!
Actual battery service life depends on the Alarm and the environment in which it is installed. All the batteries specified above are acceptable replacement batteries for this unit. Regardless of the manufacturer's suggested battery life, you MUST replace the battery immediately once the unit starts "chirping" (the "low battery warning").

To replace the batteries (without removing Alarm from the ceiling or wall):

- Open the battery compartment.
- Press tabs A and B as shown in the diagram and remove each battery.
- Insert the new batteries, making sure they snap completely into the battery compartment. Match the terminals on the ends of the batteries with the terminals on the unit.
- Close the battery compartment, and then test the unit by pressing the Test/Silence button.

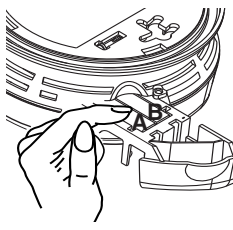

IF YOUR SMOKE/CO ALARM SOUNDS

WHAT TO DO FIRST— IDENTIFY THE TYPE OF ALARM SIGNAL

Refer to previous section "What you will see and hear with this alarm".

IF THE CO ALARM SOUNDS

"ALARM—MOVE TO FRESH AIR"
If you hear the CO alarm horn and the CO red light is flashing, move everyone to a source of fresh air. DO NOT remove the batteries!

AWARNING!

Action of your CO Alarm indicates the presence of carbon monoxide (CO) which can kill you. In other words, when your CO Alarm sounds, you must not ignore it!

IF THE CO ALARM SIGNAL SOUNDS:

- Operate the Test/Silence button.
- Call your emergency services, fire department or 911. Write down the number of your local emergency service here:
- Immediately move to fresh air—outdoors or by an open door or window. Do a head count to check that all persons are accounted for. Do not re-enter the premises, or move away from the open door or window until the emergency services responder has arrived, the premises have been aired out, and your CO Alarm remains in its normal condition.
- After following steps 1-3, if your CO Alarm reactivates within a 24-hour period, repeat steps 1-3 and call a qualified appliance technician to investigate for sources of CO from fuel-burning equipment and appliances, and inspect for proper operation of this equipment. If problems are identified during this inspection have the equipment serviced immediately. Note any combustion equipment not inspected by the technician, and consult the manufacturers' instructions, or contact the manufacturers directly, for more information about CO safety and this equipment. Make sure that motor vehicles are not, and have not, been operating in an attached garage or adjacent to the residence. Write down the number of a qualified appliance technician here:

NOTE: A qualified appliance technician is defined as "a person, firm, corporation, or company that either in person or through a representative, is engaged in and responsible for the installation, testing, servicing, or replacement of heating, ventilation, air conditioning (HVAC) equipment, combustion appliances and equipment, and/or gas fireplaces or other decorative combustion equipment."

AFTER AN ALARM

After the emergency responders arrive, the premises aired out, and your CO Alarm remains in its normal condition, you can check what the highest carbon monoxide level sensed was:

Action:	Alarm Will Say:
1. Press & Hold Test Button	"Highest carbon monoxide level was ___ ppm. Please see manual." "To clear highest carbon monoxide level, press and hold test button now." "Highest carbon monoxide level cleared."
2. Press & Hold Test Button, if you would like to clear the highest level sensed. If you would like to keep the highest level in memory, do not press anything.	Alarm will say nothing.

IF THE SMOKE ALARM SOUNDS

RESPONDING TO AN ALARM

AWARNING!

- If the unit alarms and you are not testing the unit, it is warning you of a potentially dangerous situation that requires your immediate attention. NEVER ignore any alarm. Ignoring the alarm may result in injury or death.
- Never remove the batteries from a battery operated Smoke/CO Alarm to stop an unwanted alarm (caused by cooking smoke, etc.). Removing batteries disables the alarm so it cannot sense smoke, and removes your protection. Instead open a window or fan the smoke away from the unit. The alarm will reset automatically.
- If the unit alarms get everyone out of the house immediately.

WHAT TO DO IN CASE OF FIRE

- Don't panic; stay calm. Follow your family escape plan.
- Get out of the house as quickly as possible. Don't stop to get dressed or collect anything.
- Feel doors with the back of your hand before opening them, and if a door is cool, open it slowly. Don't open a hot door. Keep doors and windows closed, unless you must escape through them.
- Cover your nose and mouth with a cloth (preferably damp).
- Take short, shallow breaths.
- Meet at your planned meeting place outside your home, and do a head count to make sure everybody got out safely.
- Call the Fire Department as soon as possible from outside. Give your address, then your name.
- Never go back inside a burning building for any reason.
- Contact your Fire Department for ideas on making your home safer.

AWARNING!

Alarms have various limitations. See "General Limitations of Smoke/CO Alarms" for details.

USING THE SILENCE FEATURES

AWARNING!

Never remove the batteries to quiet an unwanted alarm. Removing the batteries disables the alarm and removes your protection.

The Silence Feature is intended to temporarily silence the horn while you identify and correct the problem. Do not use the Silence Feature in emergency situations. It will not correct a CO problem or extinguish a fire.

The Silence Feature can temporarily quiet an unwanted alarm for several minutes. You can silence this Smoke/CO Alarm by pressing the Test/Silence button on the alarm cover for at least 3-5 seconds.

After the Test/Silence button is released, the Alarm Voice will say "Horn silenced, detector active." The Red LED blinks during the silence mode a fire.

When the Smoke Alarm is Silenced	When the CO Alarm is Silenced
The Smoke Alarm will remain silent for up to 15 minutes, then return to normal operation. If the smoke has not cleared—or continues to increase—the device will go back into alarm.	The CO alarm will remain silent for up to 4 minutes. After 4 minutes, if CO levels remain potentially dangerous the horn will start sounding again, will go back into alarm.

SILENCING THE LOW BATTERY WARNING

This Silence Feature can temporarily quiet the low battery warning "chirp" for up to 8 hours if AC power is present. Press the Test/Silence button on the Alarm cover until you hear the acknowledgement "chirp".

Once the low battery warning "chirp" silence feature is activated, the unit continues to flash the green light once a minute for 8 hours. After 8 hours, the low battery "chirp" will resume. The Alarm will continue to operate as long as AC power is supplied. However, replace the batteries as soon as possible, to maintain protection in event of a power outage.

To deactivate this feature: Press the Test/Silence button again. The unit will go into Test Mode and the low battery warning will resume (LED flashes and unit sounds "chirp" once a minute).

To silence Alarms in an interconnected series:

To silence an interconnected series of Smoke/CO Alarms, you must press the Test/Silence button on the initiating alarm (The unit with the flashing red light; the red light will be off on all other Alarms.). If you press the Test/Silence on any other Alarm, it will only silence that unit, not the whole interconnected series.

SILENCING THE END OF LIFE SIGNAL

This silence feature can temporarily quiet the End of Life warning "chirp" for up to 2 days. You can silence the End of Life warning "chirp" by pressing the Test/Silence button. The horn will chirp, acknowledging that the End of Life silence feature has been activated.
After approximately 2 days, the End of Life "chirp" will resume. After approximately 2-3 weeks the End of Life warning cannot be silenced.

LATCHING FEATURES

Alarm Latch is activated after an Alarm is exposed to alarm levels of smoke or carbon monoxide. This feature will only work with AC power. After smoke or CO levels drop below alarm levels, the "Smoke/Power" or "CO" Red LED will begin to flash once every few seconds. It will continue to flash or "latch" until you clear it by testing the alarm.

This feature helps emergency responders, investigators, or service technicians identify which unit(s) in your home were exposed to alarm levels of smoke or carbon monoxide. This can help investigators pinpoint the source of smoke or CO.

Interconnected Alarms. Latching Alarm Indicator shows which Alarm(s) in the series were exposed to alarm levels of smoke or carbon monoxide.

The Latching Alarm Indicator stays ON until you clear it, so it can alert you to an alarm that occurred while you were away from home, even though smoke or CO present in the air has dropped below alarm levels.

Low Battery Latch is activated when the Alarm is in the "Low battery condition". When this occurs, the **Smoke/Power LED** flashes Green On for 2 seconds/Off for 2 seconds. This feature is designed to help you identify which Alarm needs to have the battery replaced. Although, the Alarm will sound the low battery chirp approximately once every minute, sometimes during the initial stages of "low battery", the Alarm will chirp in greater intervals than one minute, sometimes up to several hours, until the battery reaches a steady low battery level. This innovative feature eliminates the frustration of waiting for and/or identifying which unit is chirping.

"SMART INTERCONNECT" FEATURE

This Alarm includes "Smart Interconnect" which enables the Alarm to be interconnected with other First Alert® and BRK Smoke, Heat, and "Smart Interconnect" CO Alarms. When smoke is detected, all Alarms will sound the smoke horn pattern. When CO is detected, "Smart Interconnect" Alarms will sound the CO horn pattern. Alarms that do not have the "Smart Interconnect" feature will remain silent during a CO alarm.

WHAT YOU NEED TO KNOW ABOUT CO

WHAT IS CO?

CO is an invisible, odorless, tasteless gas produced when fossil fuels do not burn completely. CO is a small CO, never assume it's not present. Appliances typically do not produce CO.

These fuels include: Wood, coal, charcoal, oil, natural gas, gasoline, kerosene, and propane.

Common appliances are often sources of CO. If they are not properly maintained, are improperly ventilated, or malfunction, CO levels can rise quickly. CO is a real danger now that homes are more energy efficient. "Air-tight" homes with added insulation, sealed windows, and other weatherproofing can "trap" CO inside.

SYMPTOMS OF CO POISONING

These symptoms are related to CO POISONING and should be discussed with ALL household members.

Mild Exposure: Slight headache, nausea, vomiting, fatigue ("flu-like" symptoms).

Medium Exposure: Throbbing headache, drowsiness, confusion, fast heart rate.

Extreme Exposure: Convulsions, unconsciousness, heart and lung failure. Exposure to Carbon Monoxide can cause brain damage, death.

IMPORTANT!

This CO Alarm measures exposure to CO over time. It alarms if CO levels are extremely high in a short period of time, or if CO levels reach a certain minimum over a long period of time. The CO Alarm generally sounds an alarm before the onset of symptoms in average, healthy adults. Why is this important? Because you need to be warned of a potential CO problem while you can still react in time. In many reported cases of CO exposure, victims may be aware that they are not feeling well, but become disoriented and can no longer react well enough to exit the building or get help. Also, young children and pets may be the first affected. The average healthy adult might not feel any symptoms when the CO Alarm sounds. However, people with cardiac or respiratory problems, infants, unborn babies, pregnant mothers, or elderly people can be more quickly and severely affected by CO. If you experience even mild symptoms of CO poisoning, consult your doctor immediately!

FINDING THE SOURCE OF CO AFTER AN ALARM

Carbon monoxide is an odorless, invisible gas, which often makes it difficult to locate the source of CO after an alarm. These are a few of the factors that can make it difficult to locate sources of CO:

- House well ventilated before the investigator arrives.
- Problem caused by "backdrafting."
- Transient CO problem caused by special circumstances.

Because CO may dissipate by the time an investigator arrives, it may be difficult to locate the source of CO. **BRK Brands, Inc. shall not be obligated to pay for any carbon monoxide investigation or service call.**

POTENTIAL SOURCES OF CO IN THE HOME

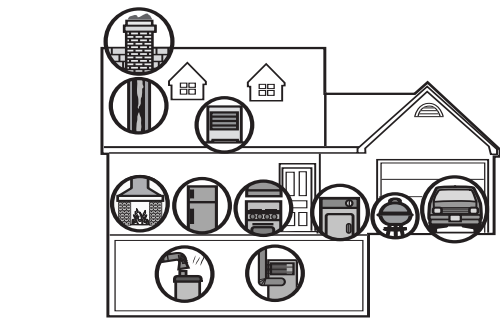

Fuel-burning appliances like: portable heater, gas or wood burning fireplace, gas kitchen range or cooktop, gas clothes dryer.

Damaged or insufficient venting: corroded or disconnected water heater vent pipe, leaking chimney pipe or flue, or cracked heat exchanger, blocked or clogged chimney opening.

Improper use of appliance/device: operating a barbecue grill or vehicle in an enclosed area (like a garage or screened porch).

Transient CO Problems: "transient" or on-again-off-again CO problems can be caused by outdoor conditions and other special circumstances.

The following conditions can result in transient CO situations:

- Excessive spillage or reverse venting of fuel appliances caused by outdoor conditions such as:
 - Wind direction and/or velocity, including high, gusty winds. Heavy air in the vent pipes (cold/humid air with extended periods between cycles).
 - Negative pressure differential resulting from the use of exhaust fans.
 - Several appliances running at the same time competing for limited fresh air.
 - Vent pipe connections vibrating loose from clothes dryers, furnaces, or water heaters.
 - Obstructions in or unconventional vent pipe designs which can amplify the above situations.
 - Extended operation of unvented fuel burning devices (range, oven, fireplace).
 - Temperature inversions, which can trap exhaust close to the ground.
 - Car idling in an open or closed attached garage, or near a home.
- These conditions are dangerous because they can trap exhaust in your home. Since these conditions can come and go, they are also hard to recreate during a CO investigation.

HOW CAN I PROTECT MY FAMILY FROM CO POISONING?

A CO Alarm is an excellent means of protection. It monitors the air and sounds a loud alarm before Carbon Monoxide levels become threatening for average, healthy adults.

A CO Alarm is not a substitute for proper maintenance of home appliances.

To help prevent CO problems and reduce the risk of CO poisoning:

- Clean chimneys and flues yearly. Keep them free of debris, leaves, and nests for proper air flow. Also, have a professional check for rust and corrosion, cracks, or separations. These conditions can prevent proper air movement and cause backdrafting. Never "cap" or cover a chimney in any way that would block air flow.
- Test and maintain all fuel-burning equipment annually. Many local gas or oil companies and HVAC companies offer appliance inspections for a nominal fee.
- Make regular visual inspections of all fuel-burning appliances. Check appliances for excessive rust and scaling. Also check the flame on the burner and pilot lights. The flame should be blue. A yellow flame means fuel is not being burned completely and CO may be present. Keep the blower door on the furnace closed. Use vents or fans when they are available on all fuel-burning appliances. Make sure appliances are vented to the outside. Do not grill or barbecue indoors, or in garages or on screen porches.
- Check for exhaust backflow from CO sources. Check the draft hood on an operating furnace for a backdraft. Look for cracks on furnace heat exchangers.
- Check the house or garage on the other side of shared wall.
- Keep windows and doors open slightly. If you suspect that CO is escaping into your home, open a window or a door. Opening windows and doors can significantly decrease CO levels.

In addition, familiarize yourself with all enclosed materials. Read this manual in its entirety, and make sure you understand what to do if your CO Alarm sounds.

REGULATORY INFORMATION FOR SMOKE/CO ALARMS

REGULATORY INFORMATION FOR CO ALARMS

WHAT LEVELS OF CO CAUSE AN ALARM?

Underwriters Laboratories Inc. Standard UL2034 requires residential CO Alarms to sound when exposed to levels of CO and exposure time as described below. They are measured in parts per million (ppm) of CO over time (in minutes).

UL2034 Required Alarm Points*:

- If the alarm is exposed to 400 ppm of CO, IT MUST ALARM BETWEEN 4 and 15 MINUTES.
- If the alarm is exposed to 150 ppm of CO, IT MUST ALARM BETWEEN 10 and 50 MINUTES.
- If the alarm is exposed to 70 ppm of CO, IT MUST ALARM BETWEEN 60 and 240 MINUTES.

* Approximately 10% COHb exposure at levels of 10% to 95% Relative Humidity (RH).

The unit is designed not to alarm when exposed to a constant level of 30 ppm for 30 days.

IMPORTANT!

CO Alarms are designed to alarm before 20 there is an immediate life threat. Since you cannot see or smell CO, never assume it's not present.

- An exposure to 100 ppm of CO for 20 minutes may not affect average, healthy adults, but after 4 hours the same level may cause headaches.
- An exposure to 400 ppm of CO may cause headaches in average, healthy adults after 35 minutes, but can cause death after 2 hours.

Standards: Underwriters Laboratories Inc. Single and Multiple Station carbon monoxide alarms UL2034.

According to Underwriters Laboratories Inc. UL2034, Section 1-1.2: "Carbon monoxide alarms covered by these requirements are intended to respond to the presence of carbon monoxide from sources such as, but not limited to, exhaust from internal-combustion engines, abnormal operation of fuel-fired appliances, and fireplaces. CO Alarms are intended to alarm at carbon monoxide levels below those that could cause a loss of ability to react to the dangers of Carbon Monoxide exposure." This CO Alarm monitors the air at the Alarm, and is designed to alarm before CO levels become life threatening. This allows you precious time to leave the house and correct the problem. This is only possible if Alarms are located, installed, and maintained as described in this manual.

Gas Detection at Typical Temperature and Humidity Ranges: The CO Alarm is not formulated to detect CO levels below 50 ppm typically. UL tested for false alarm resistance to Methane (500 ppm), Butane (300 ppm), Heptane (500 ppm), Ethyl Acetate (200 ppm), Isopropyl Alcohol (200 ppm) and Carbon Dioxide (5000 ppm). Values measure gas and vapor concentrations in parts per million.

Audible Alarm: 85 dB minimum at 10 feet (3 meters).

REGULATORY INFORMATION FOR SMOKE ALARMS

RECOMMENDED LOCATIONS FOR SMOKE ALARMS

Installing Smoke Alarms in Single-Family Residences

The National Fire Protection Association (NFPA), recommends one Smoke Alarm on every floor, in every sleeping area, and in every bedroom. In new construction, the Smoke Alarms must be AC powered and interconnected. See "Agency Placement Recommendations" for details. For additional coverage, it is recommended that you install a Smoke Alarm in all rooms, halls, storage areas, finished attics, and basements, where temperatures normally remain between 40° F (4° C) and 100° F (38° C). Make sure no door or other obstruction could keep smoke from reaching the Smoke Alarms.

More specifically, install Smoke Alarms:

- On every level of your home, including finished attics and basements.
- Inside every bedroom, especially if people sleep with the door partly or completely closed.
- In the hall near every sleeping area. If your home has multiple sleeping areas, install a unit in each. If a hall is more than 40 feet long (12 meters), install a unit at each end.
- At the top of the first-to-second floor stairway, and at the bottom of the basement stairway.

IMPORTANT!

Specific requirements for Smoke Alarm installation vary from state to state and from region to region. Check with your local Fire Department for current requirements in your area. It is recommended AC or AC/DC units be interconnected for added protection.

BATTERY OPERATED AND WIRELESS

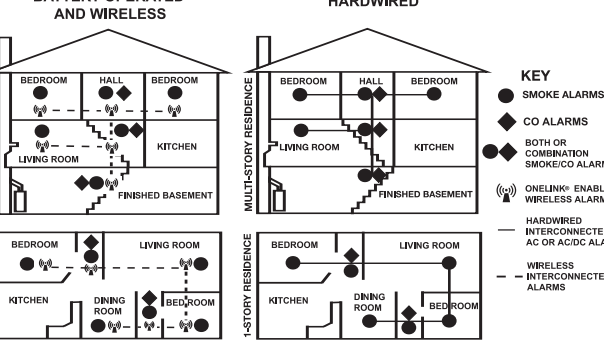

INSTALLING SMOKE ALARMS IN MOBILE HOMES

For minimum security install one Smoke Alarm as close to each sleeping area as possible. For more security, put one unit in each room. Many older mobile homes (especially those built before 1978) have little or no insulation. If your mobile home is insulated, if you are unsure of the amount of insulation, it is important to install units on inside walls only. Smoke Alarms should be installed where temperatures normally remain between 40° F (4° C) and 100° F (38° C).

AGENCY PLACEMENT RECOMMENDATIONS

Standards: Underwriters Laboratories Inc. Single and Multiple Station Smoke Alarms 217.

NFPA 72 (National Fire Code) Chapter 11

"For your information, the National Fire Protection Association's Standard 72, reads as follows:"

"11.5.1 One- and Two-Family Dwelling Units."

"11.5.1.1 Smoke Detection. Where required by applicable laws, codes, or standards for the specified occupancy, approved single- and multiple-station Smoke Alarms shall be installed as follows: (1) In all sleeping rooms. Exception: Smoke Alarms shall not be required in sleeping rooms in existing one- and two-family dwelling units. (2) Outside of each separate sleeping area, in immediate vicinity of the sleeping rooms. (3) On each level of the dwelling unit, including basements. Exception: In existing one- and two-family dwelling units, approved Smoke Alarms powered by batteries are permitted.

"A.11.8.3 Are More Smoke Alarms Desirable?"

The required number of Smoke Alarms might not provide reliable early warning protection for those areas separated by a door from the areas protected by the required Smoke Alarms. For this reason, it is recommended that the householder consider the use of additional Smoke Alarms for those areas for increased protection. The additional areas include the basement, bedrooms, dining room, furnace room, utility room, and hallways not protected by the required Smoke Alarms. The installation of Smoke Alarms in kitchens, unfinished attics, or garages is not normally recommended, as these locations occasionally experience conditions that can result in improper operation."

California State Fire Marshal (CSFM)

Early warning detection is best achieved by the installation of fire detection equipment in all rooms and areas of the household as follows: A Smoke Alarm installed in each separate sleeping area (in the vicinity, but outside bedrooms), and Heat or Smoke Alarms in the living rooms, dining rooms, bedrooms, kitchens, hallways, finished attics, furnace rooms, closets, utility and storage rooms, basements, and attached garages.

ABOUT SMOKE ALARMS

Battery (DC) operated Smoke Alarms: Provide protection even when electricity fails, provided the batteries are fresh and correctly installed. Units are easy to install, and do not require professional installation. However, they do not provide interconnected functionality.

AC powered Smoke Alarms: Can be interconnected so if one unit senses smoke, all units alarm. They do not operate if electricity fails. **AC with battery (DC) back-up:** will operate if electricity fails, provided the batteries are fresh and correctly installed. AC and AC/DC units must be installed by a qualified electrician.

Wireless Interconnected Alarms: Offer the same interconnected functionality as with hardwired alarms, without wires. Units are easy to install and do not require professional installation. They provide protection even when electricity fails, provided the batteries are fresh and correctly installed.

Smoke/CO Alarms for Solar or Wind Energy users and battery backup power systems: AC powered Smoke/CO Alarms should only be operated with true or pure sine wave inverters. Operating this Alarm with most battery-powered UPS (uninterruptible power supply) products or square wave or "quasi sine wave" inverters will damage the Alarm. If you are not sure about your inverter or UPS type, please consult with the manufacturer to verify.

Smoke Alarms for the hearing impaired: Special purpose Smoke Alarms should be installed for the hearing impaired. They include a visual alarm and an audible alarm horn, and meet the requirements of the Americans With Disabilities Act. Can be interconnected so if one unit senses smoke, all units alarm.

Smoke alarms are not to be used with detector guards unless the combination has been evaluated and found suitable for that purpose.

All these Smoke Alarms are designed to provide early warning of fires if located, installed and cared for as described in the user's manual, and if smoke reaches the Alarm. If you are unsure which type of Smoke Alarm to install, refer the National Fire Protection Association (NFPA) Standard 72 (National Fire Alarm Code) and NFPA 101 (Life Safety Code), National Fire Protection Association, One Batterymarch Park, Quincy, MA 02269-9101. Local building codes may also require specific units in new construction or in different areas of the home.

SPECIAL COMPLIANCE CONSIDERATIONS

AWARNING!

This unit alone is not a suitable substitute for complete fire detection systems in places housing many people—like apartment buildings, condominiums, hotels, motels, dormitories, hospitals, long-term health care facilities, nursing homes, day care facilities, or group homes of any kind—even if they were once single-family homes. It is not a suitable substitute for complete fire detection systems in warehouses, industrial facilities, commercial buildings, and special-purpose non-residential buildings which require special fire detection and alarm systems. Depending on the building codes in your area, this unit may be used to provide additional protection in these facilities.

The following information applies to all five types of buildings listed below:

In new construction, most building codes require the use of AC or AC/DC powered Smoke Alarms only. AC, AC/DC, DC or Wireless DC powered Smoke Alarms can be used in existing construction as specified by local building codes. Refer to NFPA 72 (National Fire Alarm Code) and NFPA 101 (Life Safety Code), local building codes, or consult your Fire Department for detailed fire protection requirements in buildings not defined as "households."

1. Single-Family Residence: Single family home, townhouse. It is recommended this unit be installed on every level of the home, in every bedroom, and in each bedroom hallway.

2. Multi-Family or Mixed Occupant Residence: Apartment building, condominium. This unit is suitable for use in individual apartments or condos, provided a primary fire detection system already exists to meet fire detection requirements in common areas like lobbies, hallways, or porches. Using this unit in common areas may not provide sufficient warning to all residents or meet local fire protection ordinances/regulations.

3. Institutions: Hospitals, day care facilities, long-term health care facilities. This unit is suitable for use in individual patient sleeping/resident rooms, provided a primary fire detection system already exists to meet fire detection requirements in common areas like lobbies, hallways, or porches. Using this unit in common areas may not provide sufficient warning to all residents or meet local fire protection ordinances/regulations.

4. Hotels and Motels: Also boarding houses and dormitories. This unit is suitable for use inside individual sleeping/resident rooms, provided a primary fire detection system already exists to meet fire detection requirements in common areas like lobbies, hallways, or porches. Using this unit in common areas may not provide sufficient warning to all residents or meet local fire protection ordinances/regulations.

5. Warehouses/Commercial Buildings: Do not use this Smoke/CO Alarm in warehouses, industrial or commercial buildings, special-purpose non-residential buildings, RVs, boats, or airplanes. This Smoke/CO Alarm is specifically designed for residential use, and may not provide adequate protection in non-residential applications.

GENERAL LIMITATIONS OF SMOKE/CO ALARMS

This Smoke/CO Alarm is intended for residential use. It is not intended for use in industrial applications where Occupational Safety and Health Administration (OSHA) requirements for Carbon Monoxide Alarms must be met. The Smoke Alarm portion of this device is not intended to alert hearing impaired residents. Special purpose Smoke Alarms should be installed for hearing impaired residents (CO Alarms are not yet available for the hearing impaired).

Smoke/CO Alarms may not wake all individuals. Practice the escape plan at least twice a year, making sure that everyone is involved — from kids to grandparents. Allow children to master fire escape planning and practice before holding a fire drill at night when they are asleep. If children or others do not readily waken to the sound of the Smoke/CO Alarm, or if there are infants or family members with mobility limitations, make sure that someone is assigned to assist them in fire drill and in the event of an emergency. It is recommended that you hold a fire drill while family members are sleeping in order to determine their response to the sound of the Smoke/CO Alarm while sleeping and to determine whether they may need assistance in the event of an emergency.

Smoke/CO Alarms cannot work without power. Battery operated units cannot work if the batteries are missing, disconnected or dead, if the wrong type of batteries are used, or if the batteries are not installed correctly. AC units cannot work if the AC power is cut off for any reason (open fuse or circuit breaker, failure along a power line or at a power station, electrical fire that burns the electrical wires, etc.). If you are concerned about the limitations of battery or AC power, install both types of units.

This Smoke/CO Alarm will not sense smoke or CO that does not reach the sensors. It will only sense smoke or CO at the sensor. Smoke or CO may be present in other areas. Doors or other obstructions may affect the rate at which CO or smoke reaches the sensors. If bedroom doors are usually closed at night, we recommend you install an alarm device (Combination CO and Smoke Alarm, or separate CO Alarms and Smoke Alarms) in each bedroom and in the hallway between them.

This Smoke/CO Alarm may not sense smoke or CO on another level of the home. Example: This alarm device, installed on the second floor, may not sense smoke or CO in the basement.

TROUBLESHOOTING GUIDE		
If the Alarm...	Problem...	You should...
Horn "chirps" about once per minute; Green "Smoke/CO" LED flashes Green On for 2 seconds/Off for 2 seconds. (Low Battery Latch is engaged.) Voice: "Replace battery in [Location]" every 5 hours	Low battery warning.	Install two new AA batteries*.
Horn sounds 3 "chirps" every minute; Voice: "Detector error in [Location, example "Basement"], please see manual" repeated every 5 hours; LED has 3 flashes with "chirps".	MALFUNCTION SIGNAL. Device is not working properly, and needs to be replaced.	Units under warranty should be returned to manufacturer for replacement. See "Limited Warranty" for details.
The light flashes (RED) and the horn sounds 5 "chirps" every minute; Voice: "Detector error in [Location, example "Basement"], please see manual" repeated every 5 hours.	END OF LIFE SIGNAL. Alarm needs to be replaced.	Immediately replace the Alarm.
Carbon Monoxide Alarm ONLY: CO Alarm goes back into alarm 4 minutes after you Silence it.	CO levels indicate a potentially dangerous situation.	IF YOU ARE FEELING SYMPTOMS OF CO POISONING, EVACUATE your home and call 911 or the Fire Department. Refer to "If The CO Alarm Sounds" for details.
CO Alarm sounds frequently even though no high levels of CO are revealed in an investigation.	The CO Alarm may be improperly located. Refer to "Where to Install This Alarm" for details.	Relocate your Alarm. If frequent alarms continue, have home rechecked for potential CO problems. You may be experiencing an intermittent CO problem.
Smoke Alarm ONLY: Smoke Alarm sounds when no smoke is visible.	Unwanted alarm may be caused by non-emergency source like cooking smoke.	Silence Alarm using manual button; clean the Alarm's cover with a soft, clean cloth. If frequent unwanted alarms continue, relocate your Alarm. Alarm may be too close to a kitchen, cooking appliance, or steamy bathroom.

*For a list of acceptable replacement batteries, see "Regular Maintenance."

If you have questions that cannot be answered by reading this manual, call Consumer Affairs at 1-800-323-9005, M-F 7:30 a.m. to 5:00 p.m. (CST)

LIMITED WARRANTY	
BRK Brands, Inc., ("BRK") the maker of First Alert® brand products warrants that for a period of seven years from the date of purchase, this product will be free from defects in material and workmanship. BRK, at its option, will repair or replace this product or any component of the product found to be defective during the warranty period. Replacement will be made with a new or remanufactured product or component. If the product is no longer available, replacement may be made with a similar product of equal or greater value. This is your exclusive warranty.	BRK shall not be liable for any incidental or consequential damages caused by the breach of any express or implied warranty. Except to the extent prohibited by applicable law, any implied warranty of merchantability or fitness for a particular purpose is limited in duration to the duration of the above warranty. Some states, provinces or jurisdictions do not allow the exclusion or limitation of incidental or consequential damages or limitations on how long an implied warranty lasts, so the above limitations or exclusion may not apply to you. This warranty gives you specific legal rights, and you may also have other rights that vary from state to state or province to province.
This warranty is valid for the original retail purchaser from the date of initial retail purchase and is not transferable. Keep the original sales receipt. Proof of purchase is required to obtain warranty performance. BRK dealers, service centers, or retail stores selling BRK products do not have the right to alter, modify or any way change the terms and conditions of this warranty.	