



AVIO™ Recessed PAR30 Halogen

Use with HB-TL, HB-52, HB-28, LB-27 Bar Hangers (Order Separately)
Performance Series



Catalog No.	Finish
XR30401WH	White
XR30401BL	Black
XR30401SL	Silver
XR30401GP	Graphite

Lamp
Four 50-75W PAR30

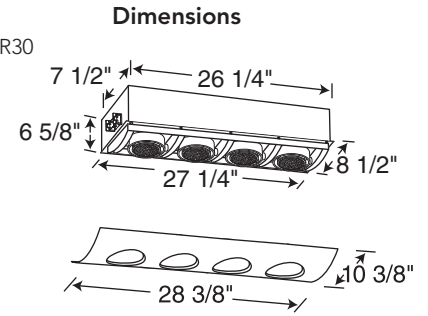

Shown with Airfoil Trim Accessory (Order Separately)

Airfoil Trim Accessory	Finish
X30401WH	White
X30401BL	Black
X30401SL	Silver
X30401GP	Graphite

Multi-Lamp



Catalog No.	Finish
XR30404WH	White
XR30404BL	Black
XR30404SL	Silver
XR30404GP	Graphite

Lamp
Four 50-75W PAR30

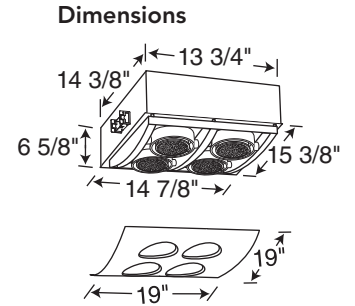

Shown with Airfoil Trim Accessory (Order Separately)

Airfoil Trim Accessory	Finish
X30404WH	White
X30404BL	Black
X30404SL	Silver
X30404GP	Graphite

Accessories For Use With XR30401, XR30404

Description	Catalog No.
25" Tru-Lock Grid Ceiling Bar Hangers, Pair	HB-TL
52" C-Channel Bar Hangers, Pair	HB-52
28" C-Channel Bar Hangers, Pair	HB-28
27" Linear Bar Hangers, Pair	LB-27
Bar Hanger conversion kit for wooden joists	HB-4

Performance Series



JUNO LIGHTING GROUP
by Schneider Electric

Multi-Lamp AVIO® Halogen PAR30



Dimensions

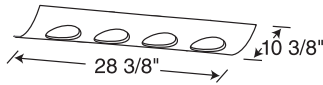
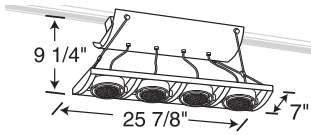

Catalog

XT30401WH
XT30401BL
XT30401SL
XT30401GP

Airfoil Trim Accessory

X30401WH
X30401BL
X30401SL
X30401GP

Finish

White
Black
Silver
Graphite

Lamp

Four 35-75W PAR30

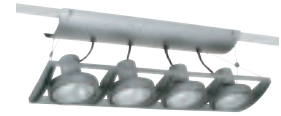

Shown with Airfoil Trim Accessory (Order Separately)

Dimensions

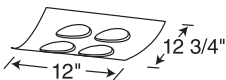
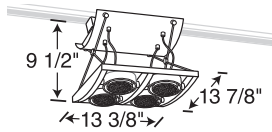

Catalog

XT30404WH
XT30404BL
XT30404SL
XT30404GP

Airfoil Trim Accessory

X30404WH
X30404BL
X30404SL
X30404GP

Finish

White
Black
Silver
Graphite

Lamp

Four 35-75W PAR30



Shown with Airfoil Trim Accessory (Order Separately)

Trac-Master®

Dimensions

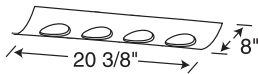
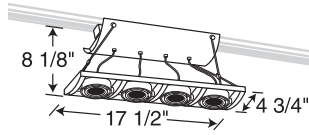

Catalog #

XT16401-20H-WH
XT16401-20H-BL
XT16401-20H-SL
XT16401-20H-GP

XT16401-39H-WH
XT16401-39H-BL
XT16401-39H-SL
XT16401-39H-GP

Airfoil Trim Accessory

X30401WH
X30401BL
X30401SL
X30401GP

Finish

White
Black
Silver
Graphite

White
Black
Silver
Graphite

White
Black
Silver
Graphite

Lamp

Four 20W CMH MR16

Four 39W CMH MR16



Dimensions

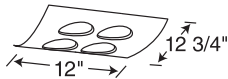
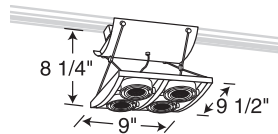

Catalog #

XT16404-20H-WH
XT16404-20H-BL
XT16404-20H-SL
XT16404-20H-GP

XT16404-39H-WH
XT16404-39H-BL
XT16404-39H-SL
XT16404-39H-GP

Airfoil Trim Accessory

X30404WH
X30404BL
X30404SL
X30404GP

Finish

White
Black
Silver
Graphite

White
Black
Silver
Graphite

Lamp

Four 20W CMH MR16

Four 39W CMH MR16



Trac-Master®

Light Control Accessories

For Fixtures: XT16401, XT16404			
Color Filters	T741-6	Diffuse Spread Lens	T7420
Dichroic Lenses	T741-18	Linear Spread Lens	T7478
Color Correction Filter	T7419	Prismatic Spread Lens	T7477
UV Filter	T7422	Hexcell Louver	T7459BL
Uniformity Lens	T7421		

Note: Accepts up to one 2" accessory.

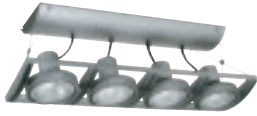

Catalog No.
XS30401WH
XS30401BL
XS30401SL
XS30401GP

Finish
White
Black
Silver
Graphite

Lamp
Four 50-75W PAR30

Dimensions

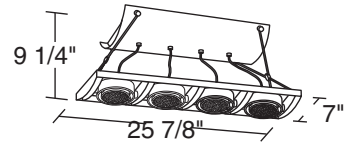

Shown with Airfoil Trim Accessory (Order Separately)

Airfoil Trim Accessory
X30401WH
X30401BL
X30401SL
X30401GP

White
Black
Silver
Graphite

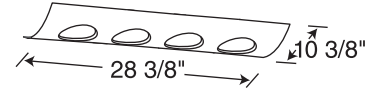

Catalog No.
XS30404WH
XS30404BL
XS30404SL
XS30404GP

Finish
White
Black
Silver
Graphite

Lamp
Four 50-75W PAR30

Dimensions

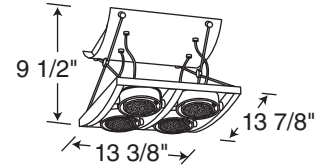

Shown with Airfoil Trim Accessory (Order Separately)

Airfoil Trim Accessory
X30404WH
X30404BL
X30404SL
X30404GP

White
Black
Silver
Graphite

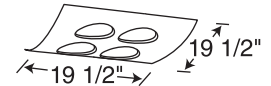

Multi-Lamp

Performance Series



JUNO LIGHTING GROUP
by Schneider Electric