

Project: _____

Fixture Type: _____

Location: _____

Contact/Phone: _____

4" VERTICAL COMPACT FLUORESCENT HOUSING

13W COMPACT FLUORESCENT LAMP

PL413EU

PRODUCT DESCRIPTION

PL Housing design for use in non-insulated areas • If installed where insulation is present, the insulation must be pulled back 3" from all sides of the PL housing.

PRODUCT SPECIFICATIONS

Lamp One 13W Triple Tube (4-pin) CFL lamp (CFTR13W/GX24q).

Socket Fixed mounted socket attaches to top of housing.

Ballast 120V thru 277V HPF Rapid Start Electronic with end-of-life lamp protection • UL listed/CSA certified.

Trims Trim selection shown on reverse.

Labels UL listed for through-branch wiring and damp locations • Union made • UL and C-UL Listed • Trims 11, 12, 4101 and 4102 are wet location approved for covered ceiling applications.

Testing All reports are based on published industry procedures; field performance may differ from laboratory performance.

Product specifications subject to change without notice.

INSTALLATION

Real Nail 3 Bar Hangers Telescoping, patented Real Nail® 3 system permits quick placement of housing anywhere within 24" O.C. joists or suspended ceilings • Integral T-bar notch and clip secures housing in suspended ceiling grid – no accessory clips required • 24" expansion stop allows quick placement of fixture in standard grid spacing • Bars scored in two locations for fast, clean breaking, allowing housing installation in tight applications • Bars captive to mounting frame • Edge-mounted for extra strength • Captive bugle-headed ring shank nail for quick one-step installation and easy removal with claw hammer for fixture relocation • Quick-Loc slot and oversized locking set screw lock fixture in position • Bar hanger foot contoured to align to bottom of construction joist • Alternate mounting holes included.

Junction Box Pre-wired junction box provided with (5) ½" and (1) ¾" knockouts, (4) Non-metallic sheathed cable connectors and ground wire, UL and C-UL Listed for through-branch wiring, maximum (8) No. 12 AWG 90° C branch circuit conductors (4 in, 4 out) • Junction box provided with removable access plates • Knockouts equipped with pryout slots.

Mounting Frame 22-gauge die-formed galvanized steel mounting frame • Rough-in section (junction box, mounting frame, housing ballast and bar hangers) fully assembled for ease of installation.

Housing Aluminum housing is vertically adjustable to accommodate up to a 1" ceiling thickness.

DIMENSIONS

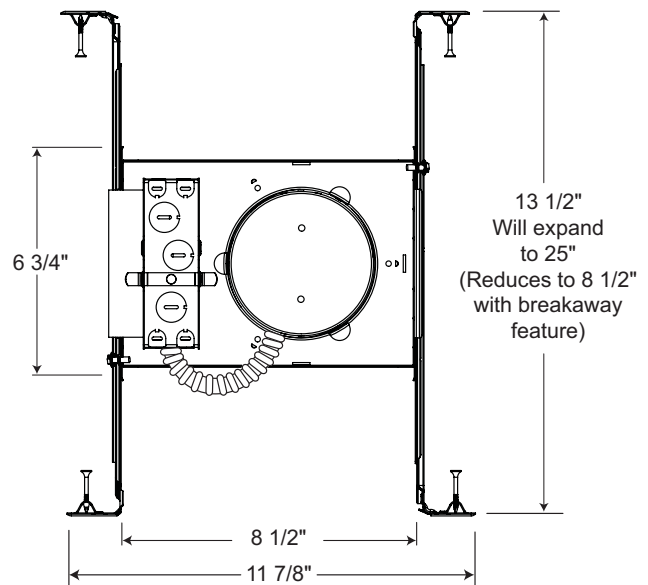
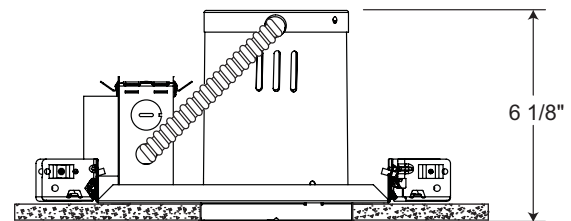

4 1/2" CEILING CUTOUT

PRODUCT CODES













Catalog Number	Input Voltage	Lamp Rating (max.)	Ballast
PL413EU	120V - 277V	13W Triple Tube (4-pin) CFL	HPF

4" VERTICAL COMPACT FLUORESCENT HOUSING

1 3W COMPACT FLUORESCENT LAMP

PL413EU

TRIMS/LAMPS

Cat. No.	Description	Max. Lamp Rating	Cat. No.	Description	Max. Lamp Rating
 11-WH ♦	Drop Opal	1 3W Triple Tube (4-pin) CFL lamp	 4101-WH ♦ 4101-SC ♦ 4101-ABZ ♦	Beveled Dome Shower Beveled Dome Shower Beveled Dome Shower	1 3W Triple Tube (4-pin) CFL lamp
 13-WH	2" Pinhole with Integral Shield	1 3W Triple Tube (4-pin) CFL lamp	 4102-WH ♦ 4102-SC ♦ 4102-ABZ ♦	Beveled Shower Beveled Shower Beveled Shower	1 3W Triple Tube (4-pin) CFL lamp
 14B-WH 14B-SC 14B-ABZ 14B-BL 14W-WH	Black Baffle Black Baffle Black Baffle Black Baffle White Baffle	1 3W Triple Tube (4-pin) CFL lamp	 4103FROST-WH 4103FROST-SC	Beveled Cylinder Beveled Cylinder	1 3W Triple Tube (4-pin) CFL lamp
 17CLI-WH 17G-WH 17B-WH 17PT-SC 17W-WH 17HZ-WH 17WHZ-WH 17WHZ-ABZ	Cone - Clear Low Iridescent Alzak® Cone - Gold Alzak® Cone - Black Alzak® Cone - Pewter Alzak® Cone - Gloss White Cone - Haze Cone - Wheat Haze Cone - Wheat Haze	1 3W Triple Tube (4-pin) CFL lamp	 4104HZ-SC 4104WHZ-ABZ	Beveled Cone Beveled Cone	1 3W Triple Tube (4-pin) CFL lamp
 4150MESH-SC	Cylinder	1 3W Triple Tube (4-pin) CFL lamp			
 170CLI-WH 170HZ-WH 170WHZ-WH	Cone - Clear Low Iridescent Alzak® Cone - Haze Cone - Wheat Haze	1 3W Triple Tube (4-pin) CFL lamp			
Optimized for CFL					
 140B-WH 140W-WH	Black Baffle White Baffle	1 3W Triple Tube (4-pin) CFL lamp			
Optimized for CFL					
 12W-WH ♦ 12W-SC ♦ 12W-ABZ ♦	Shower Trim, frosted perimeter lens Shower Trim, frosted perimeter lens Shower Trim, frosted perimeter lens	1 3W Triple Tube (4-pin) CFL lamp			

Trim Size: 5" O.D.

Trim Finish: ABZ - Classic Aged Bronze, BL - Black, SC - Satin Chrome, WH - White.
Alzak is a registered trademark of Alcoa Corp.

Note: In Canada when insulation is present, Type IC fixtures must be used.

♦ UL Listed for use in wet location.